



YASKAWA Energy-Saving Unit

Power Regenerative Converter

D1000

200 V Class, 5.0 to 130 kW
400 V Class, 5.0 to 630 kW

D



Certified for
ISO9001 and
ISO14001



JQA-0422 JQA-EM0498

Increase Your Power!

You can save more energy with AC drives. The solution is in "power regeneration". Traditionally regenerative energy was discarded as heat, but now the Yaskawa D1000 series of energy-saving units allows you to reuse regenerative energy without wasting it. You saved energy with AC drives, you saved energy with high-efficiency motors, and now you can save energy in a third way, "power regeneration". D1000 makes the most of AC drives to help you save more electricity in your equipment.



D1000



Energy-Saving Triangle



AC Drive



Motor

Reuse the Previously Wasted Energy with a New Way to Save Energy

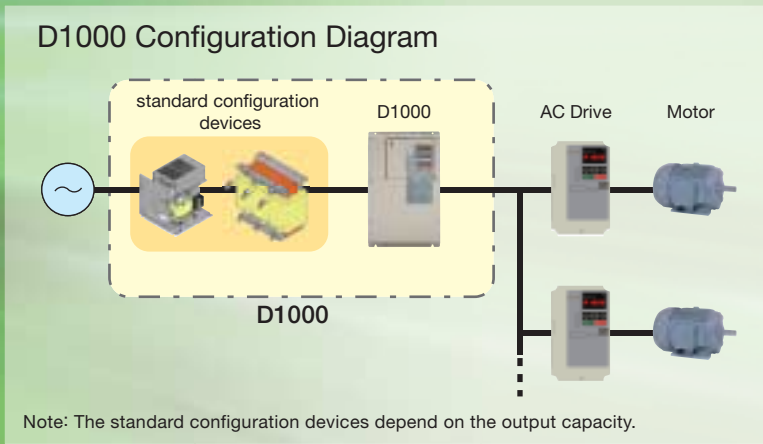
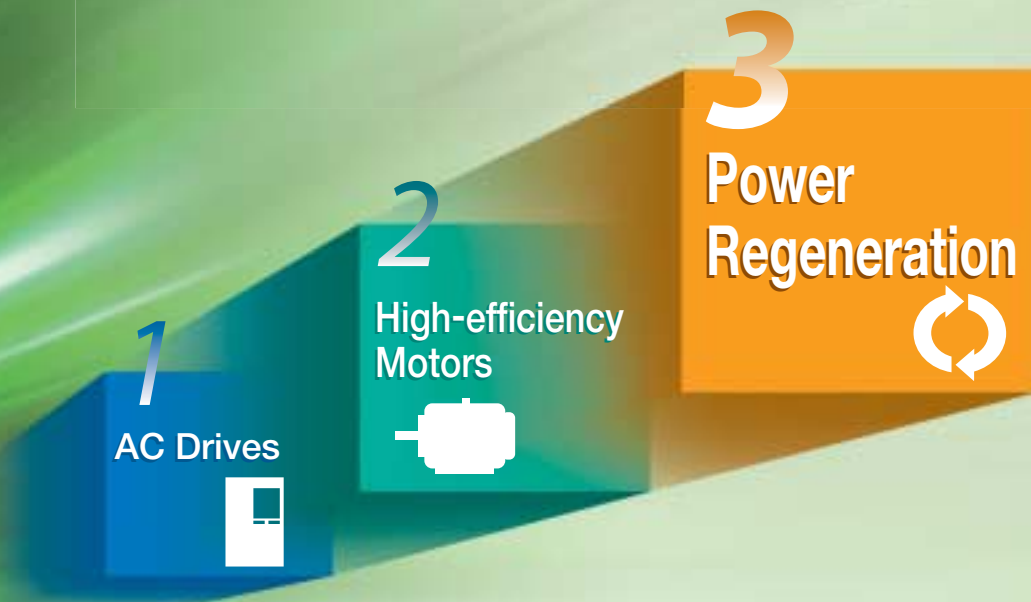

Save electricity with power regeneration!

Low harmonics!

Improved power factor!

Connect Multiple Units!

CONTENTS

Features	4
Application Examples	6
Applicable Models	7
Standard Specifications	8
Selecting the Capacity	10
Connection Diagram	11
Terminal Functions	16
Dimensions	18
Fully-Enclosed Design	22
Peripheral Devices and Options	24
Application Notes	30
Global Service Network	33



RoHS compliant

Restriction of Hazardous Substances Directive
 Note: The model CIMR-DT0A000000 that bears the  mark conforms to Korean Radio Waves Act and is designated for use in Asia (Region code: T).

Let us help you improve the quality of your power.

Save More Energy

Save More Electricity with Power Regeneration

Combined with drives or servo systems, D1000 lets you effectively use energy by returning regenerative energy to the power supply.

Return Electricity with Power Regeneration

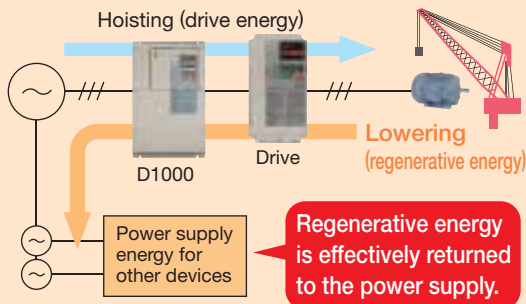

Reduce Wasteful Heat Loss

You can greatly reduce heat loss from power supply facilities caused by harmonics.

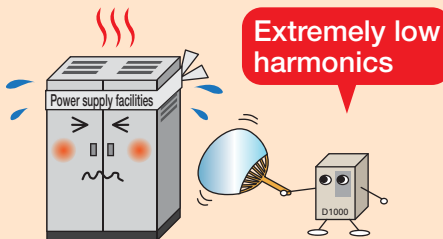

Connect Multiple Units

Save Energy with Regenerative Energy

In equipment that uses many drives or many servos, you can save energy by using all of the regenerative energy that you used to waste as the energy for other equipment.

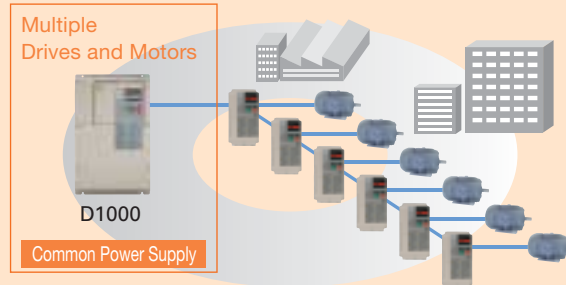

Supply Stable DC Voltages

You can supply a stable DC voltage to drives and servo systems without being influenced by fluctuations in the input AC voltage.

Energy Savings That You Can See

Visualizing Savings in Electricity

You can use analog outputs and communications networks to easily and visually monitor all sorts of data. Operation is as easy as for a Yaskawa 1000-series AC drive.

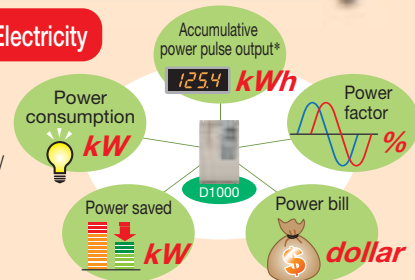

Solve Your Harmonics Issues

Low Harmonics

Low harmonics greatly reduce the distortion of the input power supply current waveform. You do not need a separate harmonic compensator to reduce harmonics to the same degree as an active filter.

Input Power Supply Current Waveform Comparison

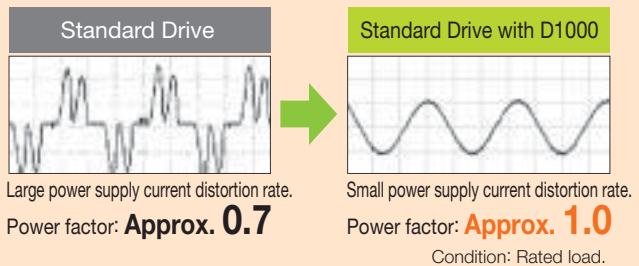

Reduce Power Supply Capacity

Improved Power Factor

Reduce costs

With power supply power factor 1 control*, you can use a lower power supply capacity. You can also reduce wiring and downsize power receiving equipment and generator capacity, which will help you reduce costs. By improving the power factor, you can expand equipment without increasing the capacity of existing power supply facilities.

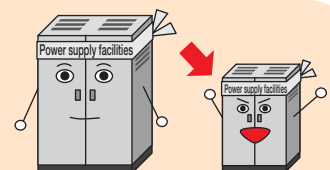

$$\text{Power usage (kW) [active power]} = \sqrt{3} \times V \times I \times \cos\theta$$

Power capacity (kVa) [apparent power]
Power factor

* : Power supply power factor 1 control: Control in which the power supply phase voltage and power supply current are in the same phase (power factor of 1).

Let Us Meet Your Needs

Reduce Your Maintenance Costs

Long Life Performance!

Ten Years of Durable Performance

Cooling fans, capacitors, and relays have been carefully selected and designed for a life expectancy of up to ten years.*

* : Assumes the drive is running continuously for 24 hours a day at 80% load with an ambient temperature of 40°C.

Easy Maintenance!

Terminal Board with a Parameter Backup Function

The terminal block's ability to save parameter setting data makes it a breeze to get the application back online in the event of a failure requiring unit replacement.



Terminal Block

Parameter			
Name	Number	Setting	
Run Command Selection 1	b1-02	2	
DC Bus Voltage Reference	d8-01	680	
Multi-function Analog Inputs (Voltage), Terminal A1 Function Selection	H3-02	10	

Performance Life Monitors

The D1000 is equipped with performance life monitors that notify the user of part wear and maintenance periods to prevent problems before they occur.

- The D1000 outputs a signal to the control device indicating components may need to be replaced

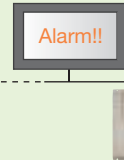

Operator Display	Corresponding Component
LT-1	Cooling fan
LT-2	Capacitors
LT-3	Inrush prevention relay

Engineering Tool DriveWizard Plus



- Manage the unique settings for all your D1000 right on your PC
- An indispensable tool for D1000 setup and maintenance. Edit parameters, access all monitors, create customized operation sequences, and observe D1000 performance with the oscilloscope function.

Parameter Copy Function

- All standard models are equipped with a Parameter Copy function using the keypad that allows parameter settings to be easily copied from the drive or uploaded for quick setup.
- A USB Copy Unit is also available as an even faster, more convenient way to back up settings and instantly program the drive.

Global Standards

We Support Global Business!

Compliance with Global Standards



RoHS compliant

Restriction of Hazardous Substances Directive
 Note: The model CIMR-DT that bears the mark conforms to Korean Radio Waves Act and is designated for use in Asia (Region code: T).

Support for Field Networks

RS-422/RS-485 communications capability with the MEMOBUS/Modbus protocol is a standard feature. And you can mount communications options cards to enable using the main open field networks.

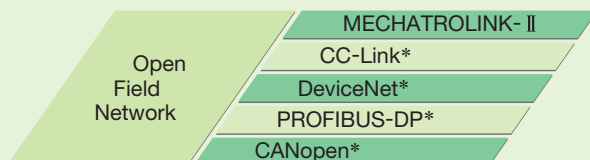

* : Available soon.

Greater Downsizing

More Compact and Less Wiring!

Modules for peripheral devices, such as reactors, enable downsizing and reduce wiring. What you achieve is more compact equipment.

Comparison with Previous System (for 400 V, 20 kW)

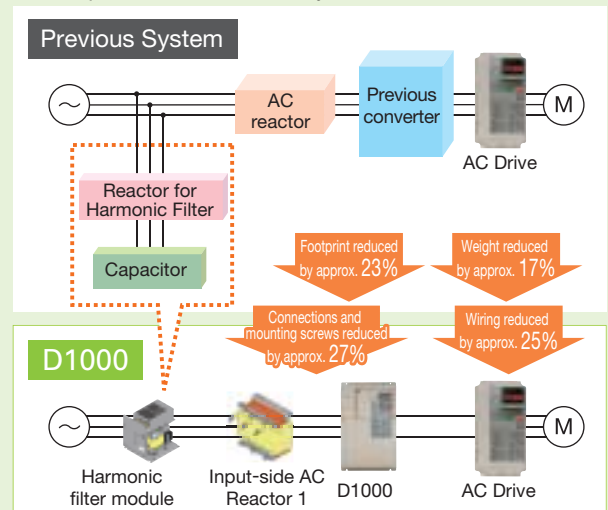

Features

Application Examples

Applicable Models

Standard Specifications

Selecting the Capacity

Connection Diagram

Terminal Functions

Dimensions





Fully-Enclosed Design

Peripheral Devices and Options

Application Notes

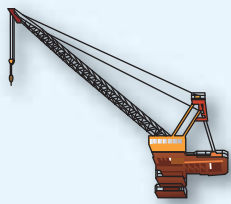
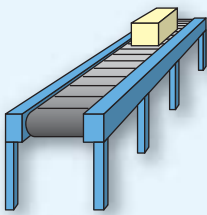
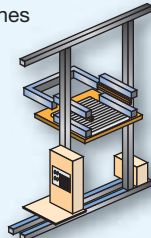
Global Service Network

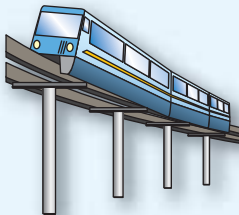
Conveyance Equipment

<p>Cranes, Hoists, and Chain Blocks</p>  	<p>Conveyors</p>  	<p>Elevators</p>  
<p>Stacking Cranes (Automated Warehouses)</p>  	<p>Escalators</p>  	<p>Automated Vertical Storage System</p>  
<p>Slope Transportation Systems (Monorails and Cable Cars)</p>  		<p>Automatic Parking System</p>  

<p>Robots</p>	<p>Textiles</p>	<p>Metal Fabrication</p>
<p>Robots</p>  	<p>Weaving Machines</p>  	<p>Presses</p>  

<p>Chemical Plants</p>	<p>Food Processing</p>	<p>Medical Facilities</p>
<p>Centrifugal Separators, Decanters</p>  	<p>Mixers</p>  	<p>Medical Devices</p>  



Improved Power Factor



Low Harmonics





Power Regeneration



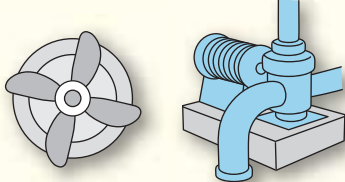

Multiple Drive Connection

HVAC&R		Paper Manufacturing and Printers
--------	--	----------------------------------



Fans and Pumps



Compressors

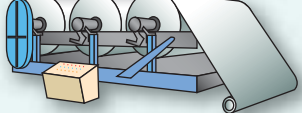

Winders and Rewinders

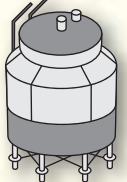

Cooling Towers

Air Conditioning Systems

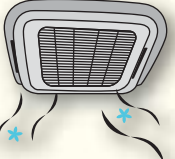

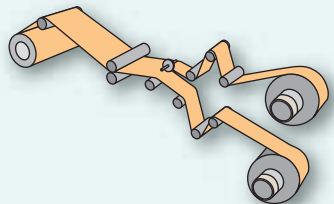

Slitters



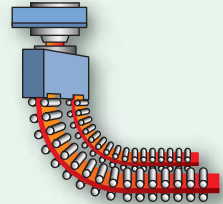

Other

Ladle Turrets

Machine Tools

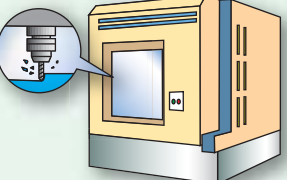
DC Multi-link Drives





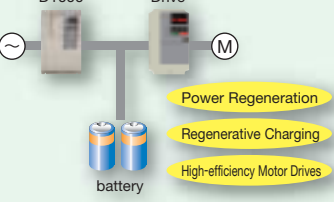



- Power Regeneration
- Regenerative Charging
- High-efficiency Motor Drives



Applicable Models

The following AC drives and AC Servo drives are recommended. The D1000 can be connected to existing products.

					
High performance vector control A1000	Compact vector control V1000	Compact V/f control J1000	High-function fully vector control Varispeed G7	Elevator applications L1000A	AC servo drives Σ-V SERIES



Features
Application Examples
Applicable Models
Standard Specifications
Selecting the Capacity
Connection Diagram
Terminal Functions
Dimensions
Fully-Enclosed Design
Peripheral Devices and Options
Application Notes
Global Service Network

Standard Specifications

Standard Specifications

D1000 Energy-saving Unit



Voltage		200 V Class								400 V Class											
Model CIMR-DA*1A:.....		0005	0010	0020	0030	0050	0065	0090	0130	0005	0010	0020	0030	0040	0060	0100	0130	0185	0270	0370	0630
Max. Applicable Motor Capacity kW		3.7	7.5	15	22	37	55	75	110	3.7	7.5	15	22	30	45	75	110	160	220	315	560
Rating	Rated Output Capacity*2 kW	5	10	20	30	50	65	90	130	5	10	20	30	40	60	100	130	185	270	370	630
	Rated Output Current (DC) A	15	30	61	91	152	197	273	394	8	15	30	45	61	91	152	197	280	409	561	955
	Rated Input Current (AC) A	15	29	57	83	140	200	270	400	8	16	30	43	58	86	145	210	300	410	560	1040
	Rated Output Voltage	330 Vdc								660 Vdc											
Input	Rated Voltage/Rated Frequency	200 to 240 Vac 50/60 Hz								380 to 480 Vac 50/60 Hz											
	Allowable Voltage Fluctuation	-15 to +10%																			
	Allowable Frequency Fluctuation	±2%																			
Control Characteristics	Control Method	Sine-wave PWM control																			
	Input Power Factor	Input power factor of 0.99 min. (for rated operation)																			
	Output Voltage Accuracy	±5%																			
	Overload Protection	Unit stops after 60 s at 150% of rated output current or after 3 s at 200% of rated output current.																			
	Voltage Reference Range	300 to 360 Vdc								600 to 730 Vdc											
	Carrier Frequency	6 kHz				4 kHz				6 kHz				4 kHz				2 kHz			
	Main Control Functions	Current Limit, Cooling Fan on/off Switch, Removable Terminal Block with Parameter Backup Function, MEMOBUS/Modbus Comm. (RS-422/RS-485 max, 115.2 kbps)																			
Protection Functions	Momentary Overcurrent Protection	Unit stops when input current exceeds 250%.																			
	Fuse burnout	Operation stops if the fuse burns out.																			
	Overloads	Operation stops after 60 s at 150% of rated output current.																			
		Operation stops after 3 s at 200% of rated output current. (electrical operation and regeneration)																			
	Overvoltage Protection	Output	Stops when DC bus voltage exceeds approx. 410 Vdc								Stops when DC bus voltage exceeds approx. 820 Vdc										
		Input	Stops when input voltage exceeds approx. 227 Vac								Stops when input voltage exceeds approx. 554 Vac										
	Undervoltage Protection	Output	Stops when DC bus voltage falls below approx. 190 Vdc								Stops when DC bus voltage falls below approx. 380 Vdc										
		Input	Stops when input voltage falls below approx. 150 Vac								Stops when input voltage falls below approx. 300 Vac										
	Momentary Power Loss	Immediately stops after Momentary Power Loss is detected.																			
	Power Supply Frequency Fault	Operation stops for a deviation of ±6 Hz or more from the rated input frequency.																			
Heatsink Overheat Protection	Protection by thermistor																				
Ground Fault Protection*3	Protection by electronic circuit																				
Charge LED	Charge LED remains lit until DC bus has fallen below approx. 50 V																				
Environment	Area of Use	Indoors																			
	Ambient Temperature	-10 to +50°C (IP00/IP20/Open Type enclosure)																			
	Humidity	95% RH or less (no condensation)																			
	Shock	(2A0005 to 2A0050, 4A0005 to 4A0100) 10 to 20 Hz : 9.8 m/s ² , 20 to 55 Hz : 5.9 m/s ²																			
		(2A0065 to 2A0130, 4A0130 to 4A0370) 10 to 20 Hz : 9.8 m/s ² , 20 to 55 Hz : 2.0 m/s ² (4A0630) 10 to 20 Hz : 5.9 m/s ² , 20 to 55 Hz : 2.0 m/s ²																			
	Storage Temperature	-20 to +60°C (short-term temperature during transportation)																			
Altitude	Up to 1000 meters (derating required at altitudes from 1000 m to 3000 m)																				
Protection Design	IP00/IP20/Open Type enclosure																				
Safety Standard	UL508C, IEC61800-5-1, IEC61800-3																				

*1 : This number indicates the voltage class (2: 200 V class, 4: 400 V class).

*2 : For the 200 V class, rated output capacity is calculated with a rated output voltage of 220 V. For the 400 V class, values are given for an input voltage of 440 V.

*3 : Protection may not be provided under the following conditions as the motor windings are grounded internally during run:

- Low resistance to ground from the drive cable or terminal block.
- Drive already has a short-circuit when the power is turned on.

Note: You must install a harmonic filter module and input AC reactor 1 for a D1000 of 5 to 185 kW.

You must install a reactor for the harmonic filter, a capacitor for the harmonic filter, and input AC reactors 1 and 2 for a D1000 of 270 to 630 kW.

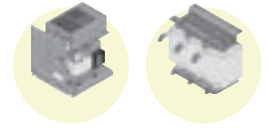

D1000 Standard Configuration Devices

Voltage		200 V									400 V										
Model CIMR-DA::A::		0005	0010	0020	0030	0050	0065	0090	0130	0005	0010	0020	0030	0040	0060	0100	0130	0185	0270	0370	0630
Harmonic Filter Module	Rated Current A	15	29	57	83	140	200	270	400	8	16	30	43	58	86	145	210	300	—	—	—
Input AC	Rated Current A	15	29	57	83	140	200	270	400	8	16	30	43	58	86	145	210	300	410	560	560
Reactor 1	Inductance mH	2.45	1.27	0.64	0.44	0.26	0.18	0.14	0.09	9.19	4.59	2.45	1.71	1.27	0.85	0.51	0.35	0.25	0.18	0.13	0.13
Input AC	Rated Current A	—	—	—	—	—	—	—	—	—	—	—	—	—	—	—	—	—	410	560	1140
Reactor 2	Inductance mH	—	—	—	—	—	—	—	—	—	—	—	—	—	—	—	—	—	0.06	0.05	0.02
Reactor for Harmonic Filter	Rated Current A	—	—	—	—	—	—	—	—	—	—	—	—	—	—	—	—	—	64	87	177
	Inductance mH	—	—	—	—	—	—	—	—	—	—	—	—	—	—	—	—	—	0.022	0.0158	0.0079
Condenser for Harmonic Filter	Rated Capacity μ F	—	—	—	—	—	—	—	—	—	—	—	—	—	—	—	—	—	290	402	800

* : This number indicates the voltage class (2: 200 V class, 4: 400 V class).
 Note: CIMR-DA::4A0630 requires two units of input AC reactor 1.

Model Number Key

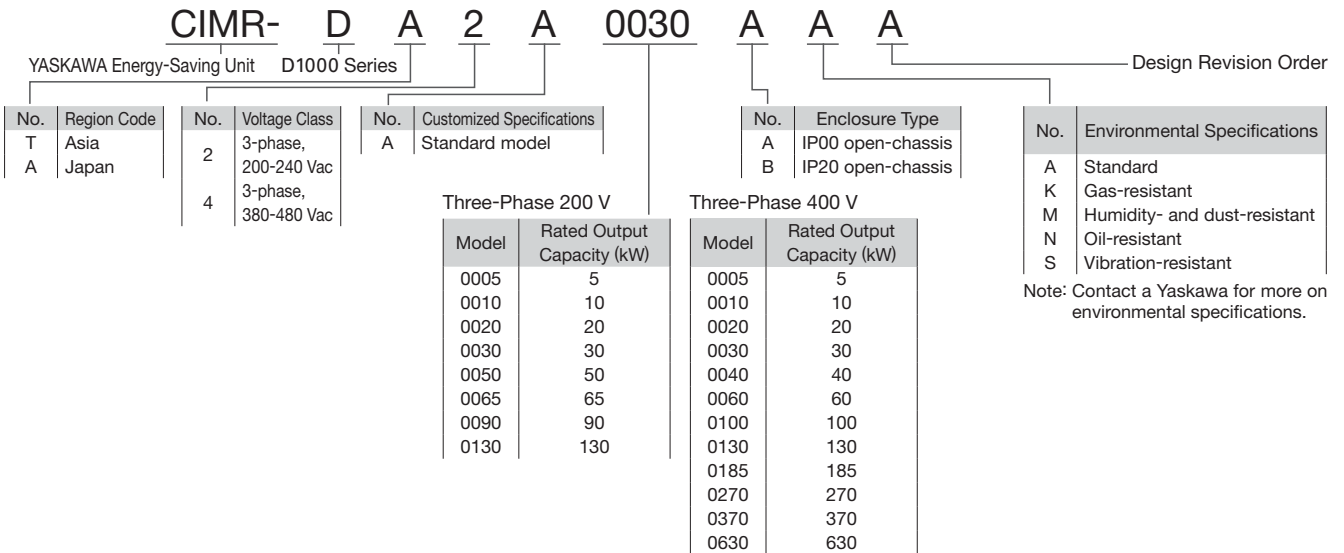

Features

Application Examples

Applicable Models

Standard Specifications

Selecting the Capacity

Connection Diagram

Terminal Functions

Dimensions

Fully-Enclosed Design

Peripheral Devices and Options

Application Notes

Global Service Network

Selecting the Capacity / Connection Diagram

● D1000 Capacity Selection



The recommended D1000 models are given in the following table when one drive is connected.

200 V Class

Motor Capacity (kW)	3.7 or less	5.5	7.5	11	15	18.5	22	30	37	45	55	75	90	110
D1000 Model CIMRDA2A	0005	●	—	—	—	—	—	—	—	—	—	—	—	—
	0010	—	●	●	—	—	—	—	—	—	—	—	—	—
	0020	—	—	—	●	●	—	—	—	—	—	—	—	—
	0030	—	—	—	—	●	●	—	—	—	—	—	—	—
	0050	—	—	—	—	—	—	●	●	—	—	—	—	—
	0065	—	—	—	—	—	—	—	—	●	●	—	—	—
	0090	—	—	—	—	—	—	—	—	—	—	●	—	—
	0130	—	—	—	—	—	—	—	—	—	—	—	●	●

400 V Class

Motor Capacity (kW)	3.7 or less	5.5	7.5	11	15	18.5	22	30	37	45	55	75	90	110	132	160	185	220	315	450	560	
D1000 Model CIMRDA4A	0005	●	—	—	—	—	—	—	—	—	—	—	—	—	—	—	—	—	—	—	—	—
	0010	—	●	●	—	—	—	—	—	—	—	—	—	—	—	—	—	—	—	—	—	—
	0020	—	—	—	●	●	—	—	—	—	—	—	—	—	—	—	—	—	—	—	—	—
	0030	—	—	—	—	●	●	—	—	—	—	—	—	—	—	—	—	—	—	—	—	—
	0040	—	—	—	—	—	—	●	—	—	—	—	—	—	—	—	—	—	—	—	—	—
	0060	—	—	—	—	—	—	—	●	●	—	—	—	—	—	—	—	—	—	—	—	—
	0100	—	—	—	—	—	—	—	—	—	●	●	—	—	—	—	—	—	—	—	—	—
	0130	—	—	—	—	—	—	—	—	—	—	—	●	●	—	—	—	—	—	—	—	—
	0185	—	—	—	—	—	—	—	—	—	—	—	—	—	●	●	—	—	—	—	—	—
	0270	—	—	—	—	—	—	—	—	—	—	—	—	—	—	—	●	●	—	—	—	—
	0370	—	—	—	—	—	—	—	—	—	—	—	—	—	—	—	—	—	●	—	—	—
	0630	—	—	—	—	—	—	—	—	—	—	—	—	—	—	—	—	—	—	●	●	—



If more than one drive is connected or for a more detailed selection, use the flowchart to select D1000 capacity.

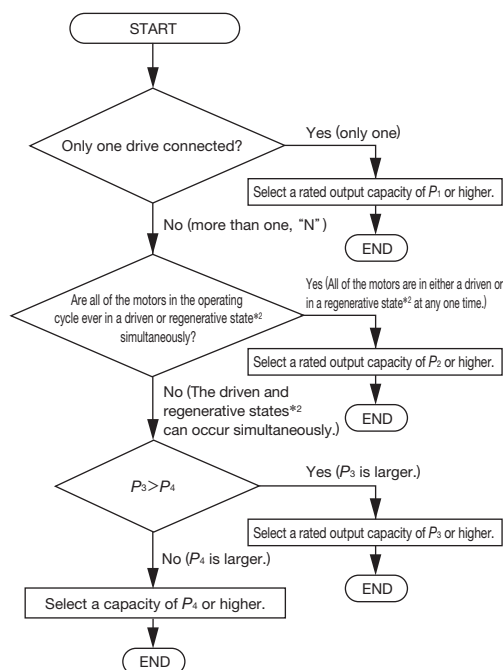

$$P_1 = \frac{\text{Motor 1 capacity (kW)}}{\text{Motor 1 efficiency}^{*1} \times \text{Drive 1 efficiency}^{*1}}$$

$$P_2 = \frac{\text{Motor 1 capacity (kW)}}{\text{Motor 1 efficiency}^{*1} \times \text{Drive 1 efficiency}^{*1}} + \frac{\text{Motor 2 capacity (kW)}}{\text{Motor 2 efficiency}^{*1} \times \text{Drive 2 efficiency}^{*1}} + \dots + \frac{\text{Motor N capacity (kW)}}{\text{Motor N efficiency}^{*1} \times \text{Drive N efficiency}^{*1}}$$

Total drive capacity*2 (or regenerative capacity*2) (kW)

$$P_3 = P_2 - (\text{Motor 1 efficiency}^{*1} \times \text{Drive 1 efficiency}^{*1} \times \text{Motor 1 capacity (kW)} + \dots + \text{Motor N efficiency}^{*1} \times \text{Drive N efficiency}^{*1} \times \text{Motor N capacity (kW)})$$

Total regenerative capacity*2 (kW)

$$P_4 = 1/3 \text{ of total drive capacity (kW)}$$

*1 : If the efficiencies of the motors and drives are known, then use them. If they are not known, use a motor efficiency of 0.9 (0.85 for 7.5 kW or less) and a drive efficiency of 0.95 (0.9 for 7.5 kW or less).

*2 : The drive capacity is the power capacity during a normal operating condition when energy is applied to the motor. The regenerative capacity is the capacity that is generated when the flow of power is reversed, such as when the drive capacity is decelerated.

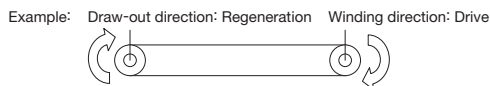

Note: 1. If the interphase voltage imbalance ratio of the power source exceeds 2%, use a unit with a frame size that is one higher than otherwise necessary. You can calculate the interphase voltage imbalance ratio of the power source with the following formula. (Conforms to IEC 61800-3 (5.2.3).)

$$\text{Interphase imbalance ratio (\%)} = \frac{\text{Maximum voltage} - \text{Minimum voltage}}{\text{Three-phase average voltage}} \times 67$$

2. Do not determine combinations based on the drive model numbers and D1000 model numbers.

● Selecting the Power Supply Capacity

Connect a power supply with a capacity (kVA) that is larger than the rated input capacity (kW) of the unit.

If a power supply with a capacity that is smaller than the rated input capacity is connected, an operating fault may occur.

If you need to connect a power supply with a capacity that is smaller than the rated input capacity, consult with your Yaskawa representative or the nearest Yaskawa sales office.

$$\text{Power Supply Capacity (kVA)} \geq \text{Rated Input Capacity (kW)}$$

$$10 \quad \text{Rated Input Capacity (kW)} = \frac{\sqrt{3} \times \text{Input Power Supply Rated Voltage (AC)} \times \text{D1000 Rated Input Current (AC)}}{1000}$$

Standard Connection Diagram

Model: CIMR-DA2A0005 to 0130, CIMR-DA4A0005 to 0185

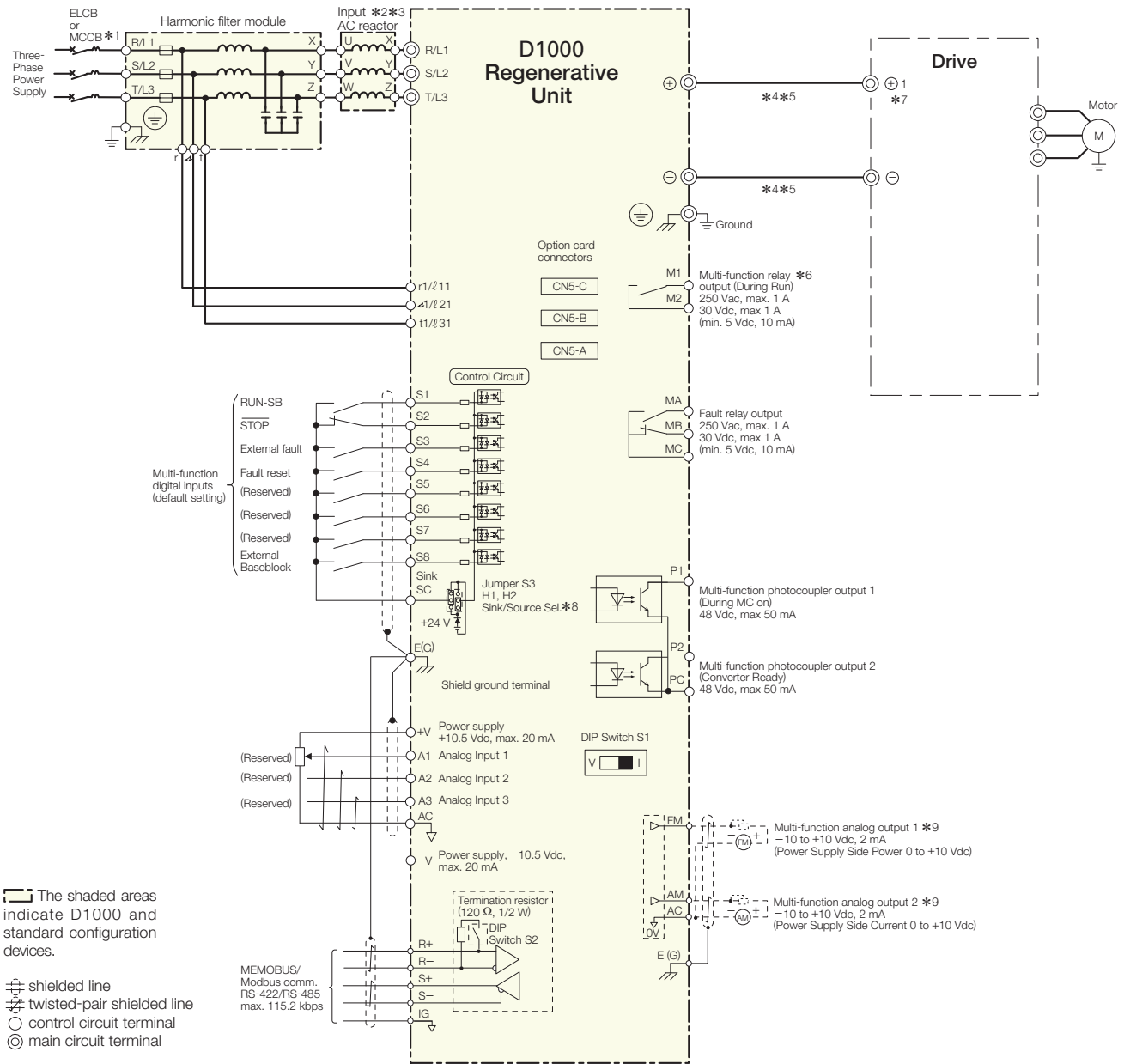

- *1 : When a noise filter is attached on D1000 power supply side, use a noise filter of the reactor type (without a capacitor) such as FINEMET(R) zero-phase reactor, and attach it after the MCCB at the power supply side. Do not use a capacitor-built-in type noise filter since the harmonic components may overheat or damage the capacitor.
- *2 : The wiring between the input AC reactor and D1000 must be within 10 m.
- *3 : Always use the specified AC reactor and harmonic filter (harmonic filter module) to avoid abnormal operations.
- *4 : The DC current bus bar wiring between D1000 and the drive must be within 5 m.
- *5 : When installing a breaker or contactor on the D1000 side for an emergency shutoff, confirm that the CHARGE indicators on the drive and D1000 are not lit before closing the breaker or contactor on the D1000 output (DC) side. If the power supply is turned on while there is a voltage charge, an overcurrent will flow and the device may be damaged. Always confirm that the breaker or contactor on the D1000 output (DC) side is turned on before applying power to the D1000.
- *6 : Make sure that the D1000 starts before the drive when the power supply is turned on. Stop the devices in the following order before you turn off the power supply: the drive, the motor, and then D1000. A fault may occur if you use the drive without operating the unit or if you turn off the power supply while the D1000 is operating.
- *7 : Do not connect a power supply to the drive's AC power supply terminals (R/L1, S/L2, and T/L3).
- *8 : This figure shows an example of a sequence input to S1 through S8 using a non-powered relay or an NPN transistor (0 V common/sink mode: default). Set either sinking or sourcing with the sinking/sourcing jumpers (S3).
- *9 : Monitor outputs work with devices such as analog frequency meters, ammeters, voltmeters, and wattmeters. Do not use these outputs in a feedback loop.

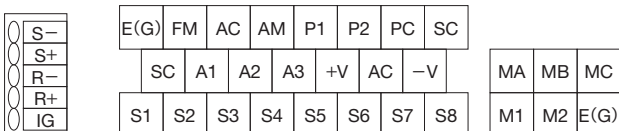

Features
Application Examples
Applicable Models
Standard Specifications
Selecting the Capacity
Connection Diagram
Terminal Functions
Dimensions
Fully-Enclosed Design
Peripheral Devices and Options
Application Notes
Global Service Network

Connection Diagram (continued)

Standard Connection Diagram

Model: CIMR-DA4A0270, 4A0370

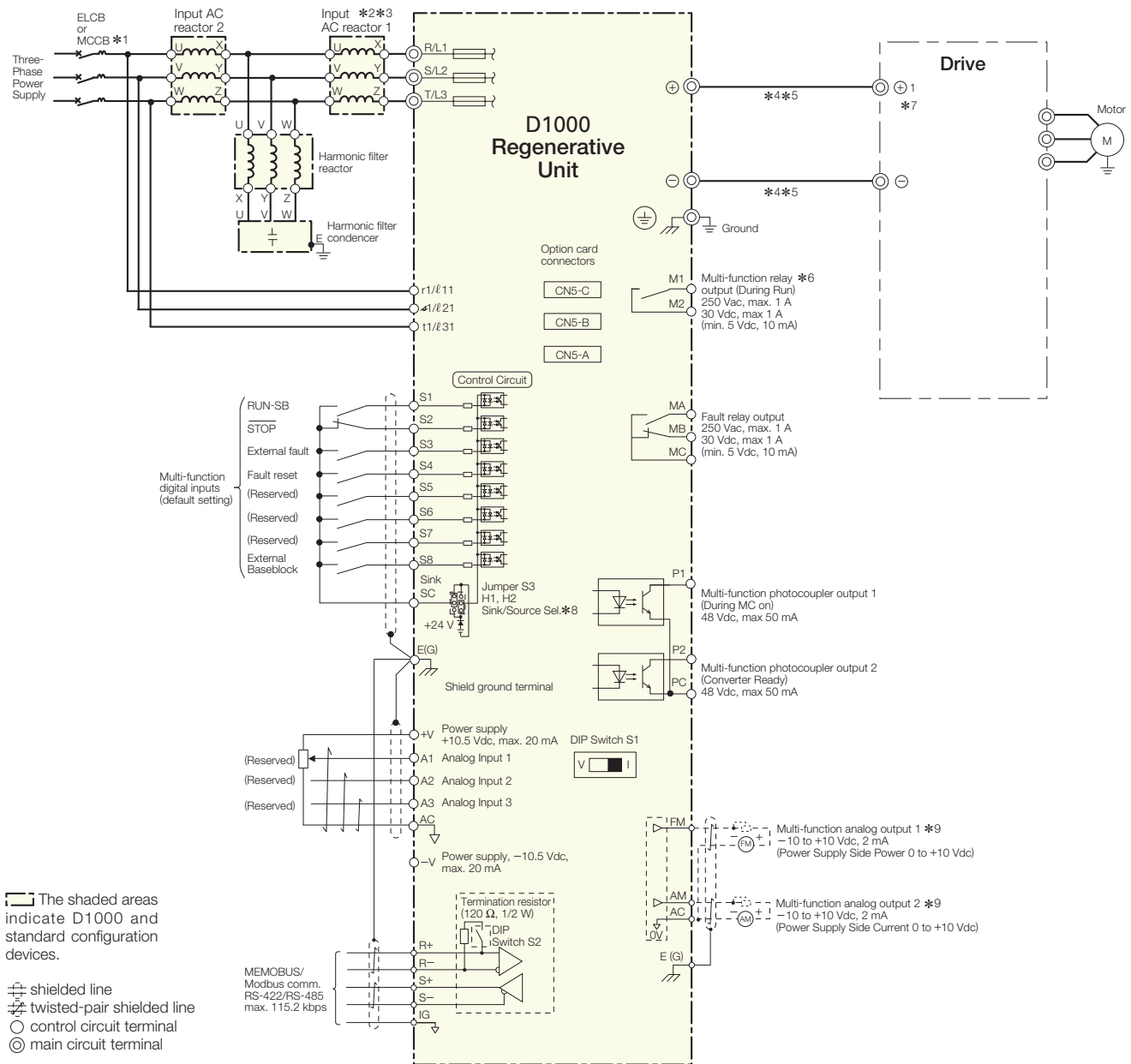

- *1 : When a noise filter is attached on D1000 power supply side, use a noise filter of the reactor type (without a capacitor) such as FINEMET zero-phase reactor, and attach it after the MCCB at the power supply side. Do not use a capacitor-built-in type noise filter since the harmonic components may overheat or damage the capacitor.
- *2 : The wiring between the input AC reactor and D1000 must be within 10 m.
- *3 : Always use the specified AC reactor and harmonic filter (harmonic filter module) to avoid abnormal operations.
- *4 : The DC current bus bar wiring between D1000 and the drive must be within 5 m.
- *5 : When installing a breaker or contactor on the D1000 side for an emergency shutoff, confirm that the CHARGE indicators on the drive and D1000 are not lit before closing the breaker or contactor on the D1000 output (DC) side. If the power supply is turned on while there is a voltage charge, an overcurrent will flow and the device may be damaged. Always confirm that the breaker or contactor on the D1000 output (DC) side is turned on before applying power to the D1000.
- *6 : Make sure that the D1000 starts before the drive when the power supply is turned on. Stop the devices in the following order before you turn off the power supply: the drive, the motor, and then D1000. A fault may occur if you use the drive without operating the unit or if you turn off the power supply while the D1000 is operating.
- *7 : Do not connect a power supply to the drive's AC power supply terminals (R/L1, S/L2, and T/L3).
- *8 : This figure shows an example of a sequence input or an NPN transistor (0 V common/sink mode: default). Set either sinking or sourcing with the sinking/sourcing jumpers (S3).
- *9 : Monitor outputs work with devices such as analog frequency meters, ammeters, voltmeters, and wattmeters. Do not use these outputs in a feedback loop.

Model: CIMR-DA4A0630

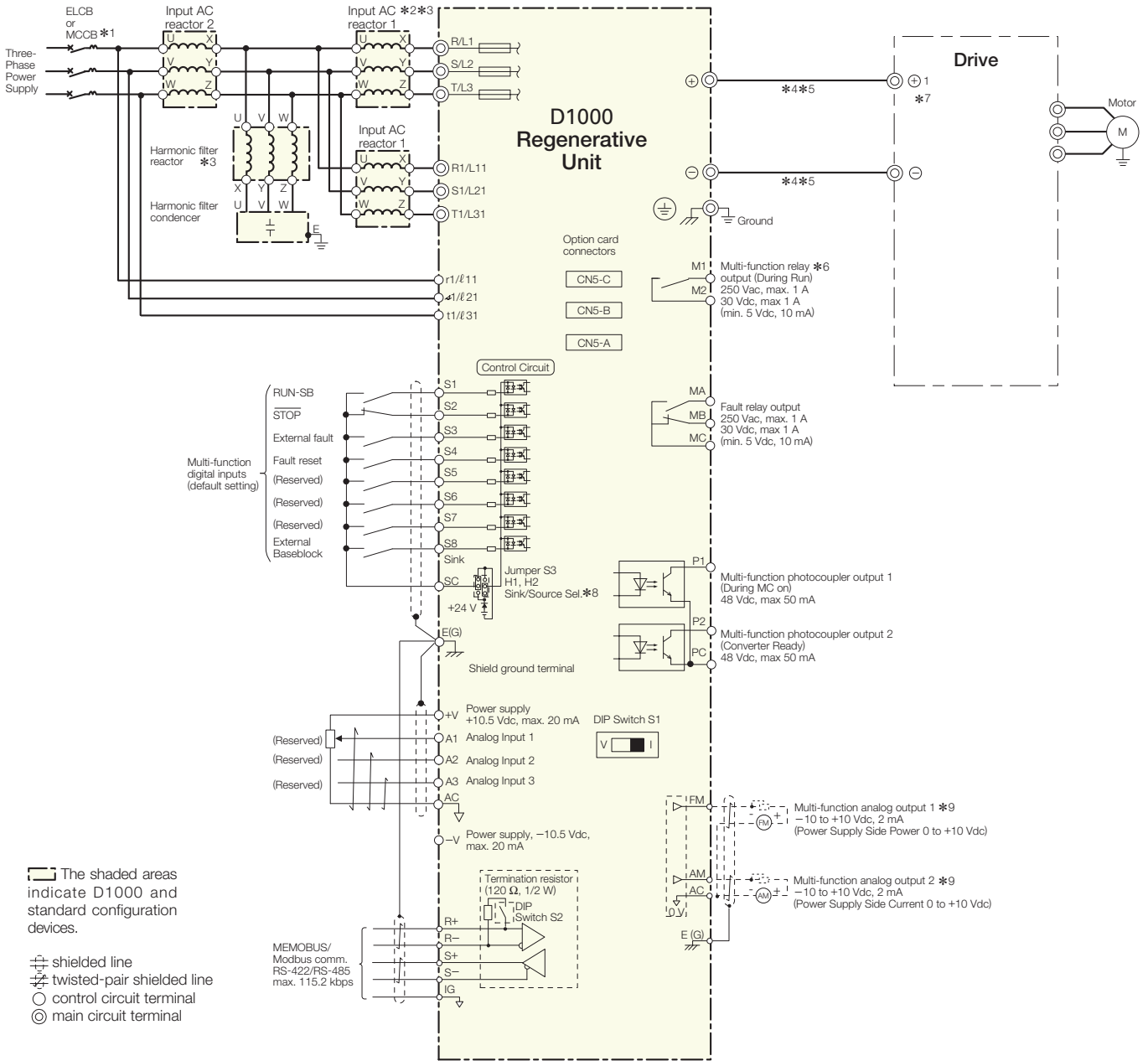

- *1 : When a noise filter is attached on D1000 power supply side, use a noise filter of the reactor type (without a capacitor) such as FINEMET zero-phase reactor, and attach it after the MCCB at the power supply side. Do not use a capacitor-built-in type noise filter since the harmonic components may overheat or damage the capacitor.
- *2 : The wiring between the input AC reactor and D1000 must be within 10 m.
- *3 : Always use the specified AC reactor and harmonic filter (harmonic filter module) to avoid abnormal operations.
- *4 : The DC current bus bar wiring between D1000 and the drive must be within 5 m.
- *5 : When installing a breaker or contactor on the D1000 side for an emergency shutoff, confirm that the CHARGE indicators on the drive and D1000 are not lit before closing the breaker or contactor on the D1000 output (DC) side. If the power supply is turned on while there is a voltage charge, an overcurrent will flow and the device may be damaged. Always confirm that the breaker or contactor on the D1000 output (DC) side is turned on before applying power to the D1000.
- *6 : Make sure that the D1000 starts before the drive when the power supply is turned on. Stop the devices in the following order before you turn off the power supply: the drive, the motor, and then D1000. A fault may occur if you use the drive without operating the unit or if you turn off the power supply while the D1000 is operating.
- *7 : Do not connect a power supply to the drive's AC power supply terminals (R/L1, S/L2, and T/L3).
- *8 : This figure shows an example of a sequence input to S1 through S8 using a non-powered relay or an NPN transistor (0 V common/sink mode: default). Set either sinking or sourcing with the sinking/sourcing jumpers (S3).
- *9 : Monitor outputs work with devices such as analog frequency meters, ammeters, voltmeters, and wattmeters. Do not use these outputs in a feedback loop.

- Features
- Application Examples
- Applicable Models
- Standard Specifications
- Selecting the Capacity
- Connection Diagram
- Terminal Functions
- Dimensions
- Fully-Enclosed Design
- Peripheral Devices and Options
- Application Notes
- Global Service Network

Connection Diagram (continued)

Drive Connections

A1000 Connection Example (Model: CIMR-DA4A0185)

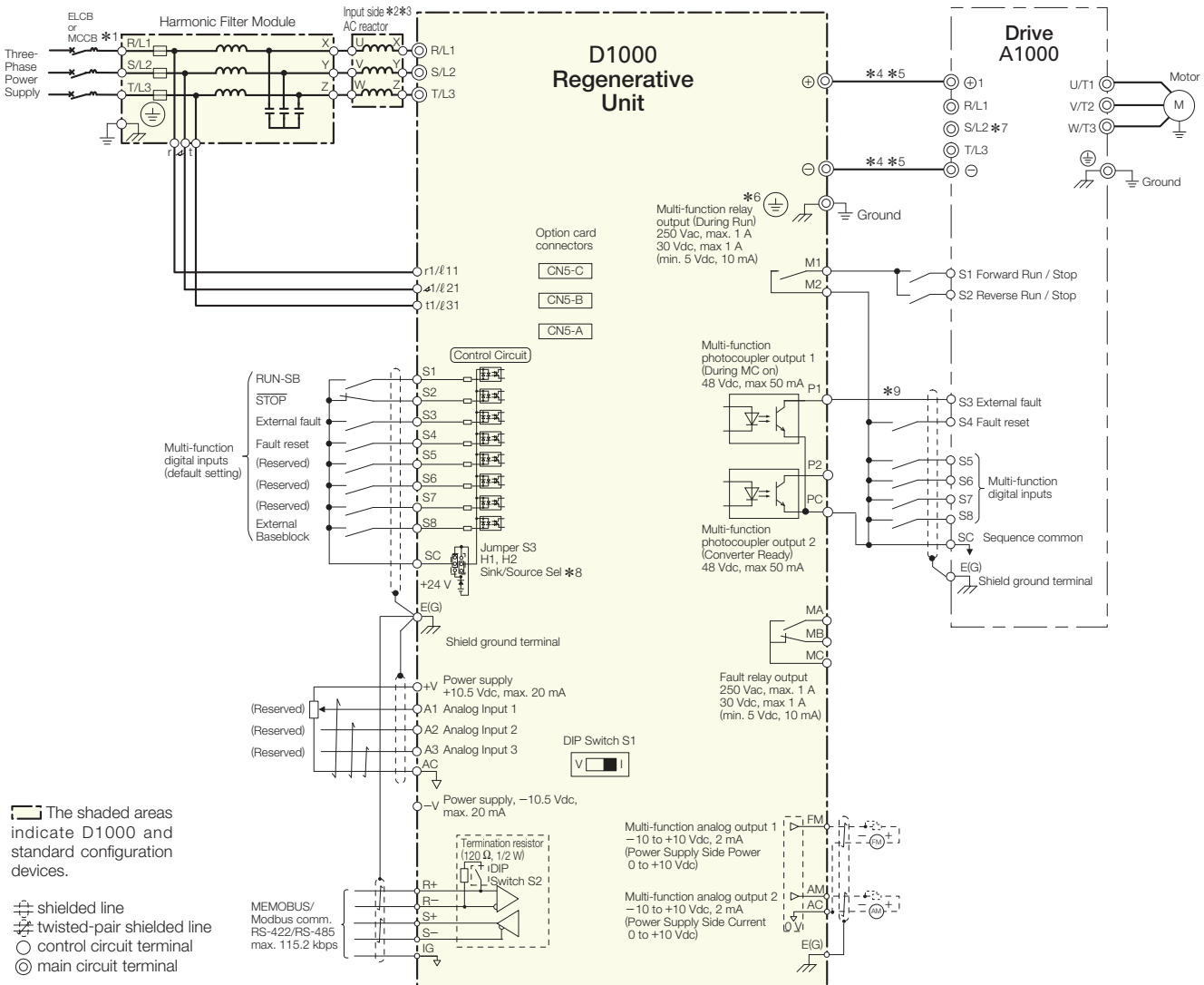

- *1 : When a noise filter is attached on D1000 power supply side, use a noise filter of the reactor type (without a capacitor) such as FINEMET zero-phase reactor, and attach it after the MCCB at the power supply side. Do not use a capacitor-built-in type noise filter since the harmonic components may overheat or damage the capacitor.
- *2 : The wiring between the input AC reactor and D1000 must be within 10 m.
- *3 : Always use the specified AC reactor and harmonic filter (harmonic filter module) to avoid abnormal operations.
- *4 : The DC current bus bar wiring between D1000 and the drive must be within 5 m.
- *5 : When installing a breaker or contactor on the D1000 side for an emergency shutoff, confirm that the CHARGE indicators on the drive and D1000 are not lit before closing the breaker or contactor on the D1000 output (DC) side. If the power supply is turned on while there is a voltage charge, an overcurrent will flow and the device may be damaged. Always confirm that the breaker or contactor on the D1000 output (DC) side is turned on before applying power to the D1000.
- *6 : Make sure that the D1000 starts before the drive when the power supply is turned on. Stop the devices in the following order before you turn off the power supply: the drive, the motor, and then D1000. A fault may occur if you use the drive without operating the unit or if you turn off the power supply while the D1000 is operating.
- *7 : Do not connect a power supply to the drive's AC power supply terminals (R/L1, S/L2, and T/L3).
- *8 : This figure shows an example of a sequence input to S1 through S8 using a non-powered relay or an NPN transistor (0 V common/sink mode: default). Set either sinking or sourcing with the sinking/sourcing jumpers (S3).
- *9 : Refer to Interlocks on page 30 for information on an interlock with the drive.

Varispeed G7 Connection Example (Model: CIMR-DA4A0185)

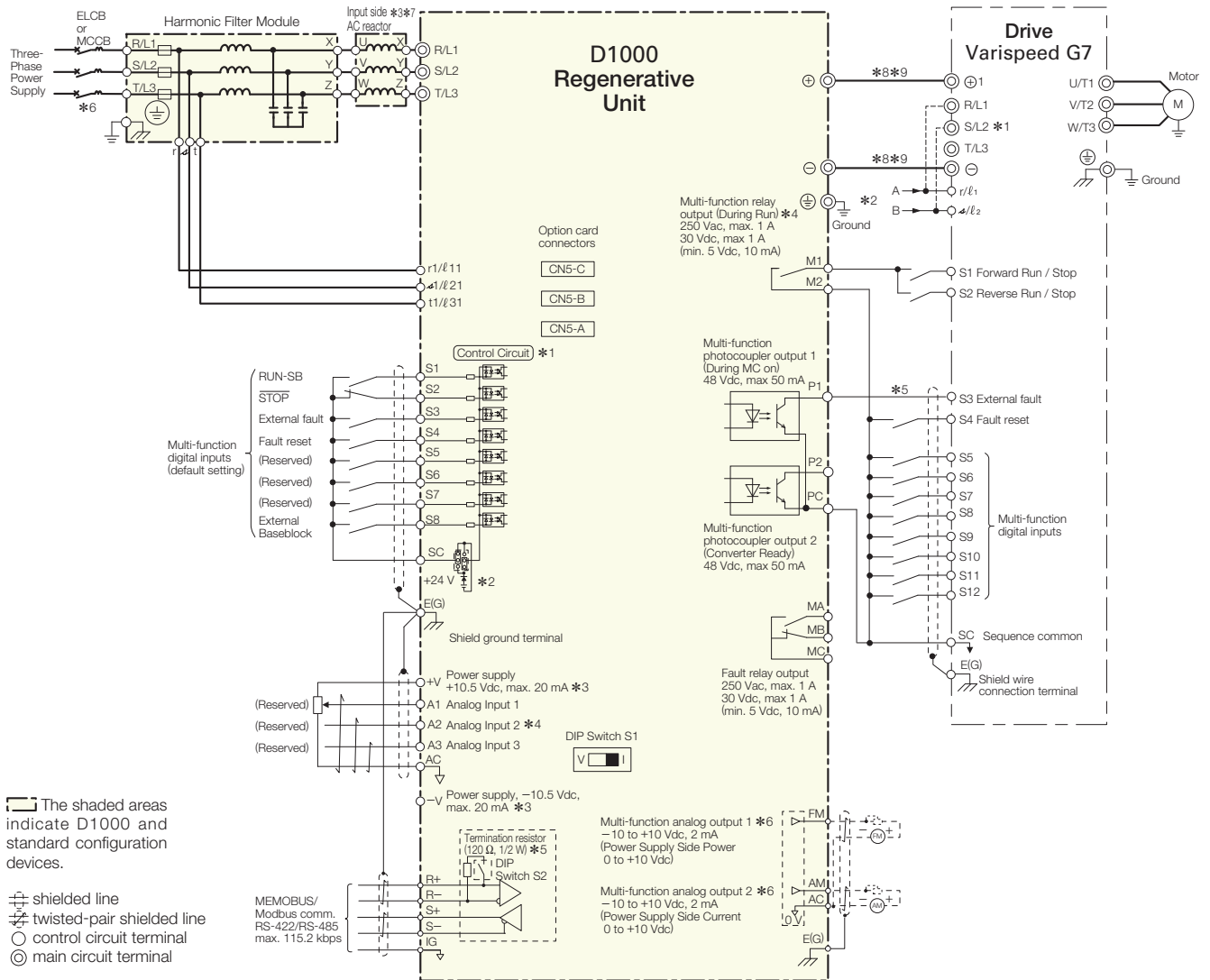

- *1 : Do not connect a power supply to the Varispeed G7's AC power supply terminals (R/L1, S/L2, and T/L3).
- *2 : For the cooling fan terminals r/l1 and a/l2 on 200 V class Varispeed G7 models for 30 to 75 kW, remove the jumper leads from between r/l1 and R/L1 and from between a/l2 and S/L2. Take the power supply from the primary power supply line to the unit.
- *3 : Always use the specified AC reactor and harmonic filter module. Operation may not be correct if non-specified devices are used.
- *4 : Sequence operation after the power supply is turned on so that the unit starts operation before the drive. Sequence stopping operation in the following order before you turn off the power supply: drive, motor, and then unit. A unit fault may occur if you operate the drive without operating the unit or turn off the power supply during unit operation.
- *5 : For information on an interlock with the drive, refer to *Interlocks* on page 30.
- *6 : If you install a noise filter on the power supply side of the unit, use a reactor-type noise filter (without a capacitor), such as a FINEMET zero phase reactor, and install it after the MCCB on the power supply side. Do not install a filter with a built-in capacitor. The harmonic components may cause the capacitor to overheat or may damage the capacitor.
- *7 : Do not use a line that is longer than 10 m to connect the input AC reactor and the unit.
- *8 : Do not use a DC bus line that is longer than 5 m to connect the unit and drive.
- *9 : When installing a breaker or contactor on the D1000 side for an emergency shutoff, confirm that the CHARGE indicators on the drive and D1000 are not lit before closing the breaker or contactor on the D1000 output (DC) side. If the power supply is turned on while there is a voltage charge, an overcurrent will flow and the device may be damaged. Always confirm that the breaker or contactor on the D1000 output (DC) side is turned on before applying power to the D1000.

Features

Application Examples

Applicable Models

Standard Specifications

Selecting the Capacity

Connection Diagram

Terminal Functions

Dimensions

Fully-Enclosed Design

Peripheral Devices and Options

Application Notes

Global Service Network

Terminal Functions

Terminal Functions

D1000 Energy-saving Unit



Main Circuit Terminals

Terminal	Type	Function
R/L1 S/L2 T/L3	Main circuit power supply inputs	These are the power supply input terminals that connect to the input reactor.
r1/ℓ11 ↵1/ℓ21 t1/ℓ31	Power supply voltage detection inputs	These terminals are to detect the power supply voltage order and voltage levels.
- +	DC voltage output	These terminals output a DC voltage
⊕	Grounding terminal	For 200 V class: 100 Ω or less For 400 V class: 10 Ω or less

Control Circuit Input Terminals (200 V/400 V Class)

Terminal Type	Terminal	Terminal Name (Default Setting)	Function (Signal Level)
Multi-Function Digital Inputs	S1	Multi-function selection input 1 (RUN-SB)	Photocoupler 24 Vdc, 8 mA The factory setting is for Sinking Mode. Use the sinking/sourcing mode jumper (S3) to change the sinking/sourcing mode setting to select an internal or external power supply. For details, refer to Sinking/Sourcing Mode Switch, 3.9 Control I/O Connections in Installation Manual (Manual No. TOEP C710656 04).
	S2	Multi-function selection input 2 (STOP)	
	S3	Multi-function selection input 3 (External fault)	
	S4	Multi-function selection input 4 (Fault reset)	
	S5	Multi-function selection input 5 (Reserved)	
	S6	Multi-function selection input 6 (Reserved)	
	S7	Multi-function selection input 7 (Reserved)	
	S8	Multi-function selection input 8 (External Baseblock)	
	SC	Multi-function selection input common	
Analog Inputs	+V	Analog reference input	10.5 Vdc (max allowable current 20 mA)
	-V	Analog reference input	-10.5 Vdc (max allowable current 20 mA)
	A1	Multi-function analog input 1 (Reserved)	-10 to +10 Vdc, 0 to 10 Vdc (input impedance: 20 kΩ)
	A2	Multi-function analog input 2 (Reserved)	-10 to +10 Vdc, 0 to 10 Vdc (input impedance: 20 kΩ) 4 to 20 mA, 0 to 20 mA (input impedance: 250Ω) Voltage or current input must be selected by DIP switch S1 and H3-09.
	A3	Multi-function analog input 3 (Reserved)	-10 to +10 Vdc, 0 to 10 Vdc (input impedance: 20 kΩ) Use DIP switch S4 on the terminal board to select between analog and PTC input.
	AC	Frequency reference common	0 V
Fault Relay Output	E (G)	Ground for shielded lines and option cards	-
	MA	N.O. output (Fault)	Relay output 30 Vdc, 10 mA to 1 A 250 Vac, 10 mA to 1 A MB N.C. output Minimum load: 5 Vdc, 10 mA
	MB	N.C. output (Fault)	
MC	Fault output common		
Multi-Function Digital Output*1	M1	Multi-function digital output (During run 1)	Default setting: During Run 1 The M1-M2 terminals close during operation. When the DC bus voltage reaches the reference value after the operation of the unit is started, the M1-M2 terminals close.
	M2		
Multi-Function Photocoupler Output	P1	Photocoupler output 1 (During MC on)	Photocoupler output*2 48 V, 2 to 50 mA
	P2	Photocoupler output 2 (Converter ready)	
	PC	Photocoupler output common	
Monitor Output	FM	Analog monitor output 1	-10 to +10 Vdc, or 0 to +10 Vdc
	AM	Analog monitor output 2	
	AC	Monitor common	

*1 : Do not assign functions to terminals M1 and M2 that involve frequent switching, unless absolutely necessary, because doing so may shorten the relay performance life. The switching life is estimated at 200,000 times (1 A, resistive load).

*2 : Connect a flywheel diode as shown when driving a reactive load such as a relay coil. The diode must be rated for use of a voltage higher than the circuit voltage.

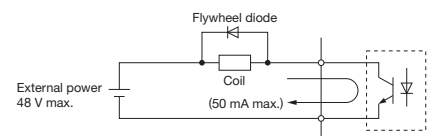

Serial Communication Terminals (200 V/400 V Class)

Type	No.	Signal Name	Function (Signal Level)
MEMOBUS/Modbus Communications*	R+	Communications input (+)	MEMOBUS/Modbus communications: Use an RS-422 or RS-485 cable to connect the unit. RS-422/RS-485 MEMOBUS/Modbus communications protocol 115.2 kbps (max.) 0 V
	R-	Communications input (-)	
	S+	Communications output (+)	
	S-	Communications output (-)	
	IG	Shield ground	

* : Enable the termination resistor in the last unit in a MEMOBUS/Modbus network by setting DIP switch S2 to the ON position.

D1000 Standard Configuration Devices [CIMR-DA2A0005 to 2A0130, CIMR-DA4A0005 to 4A0185]

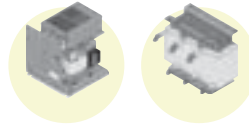

Harmonic Filter Module

Terminal	Type	Function
R/L1	Main circuit power supply inputs	These terminals are connected to the power supply.
S/L2		
T/L3		
r	Power supply voltage detection inputs	These terminals are to detect the power supply voltage order and voltage levels.
↺		
t		
X	Harmonic filter module outputs	These terminals are connected to the input AC reactor 1.
Y		
Z		
⊕	Grounding terminal	Grounding terminals For 200 V class: 100 Ω or less For 400 V class: 10 Ω or less

Input AC Reactor 1

Terminal	Type	Function
U	Input AC reactor 1 inputs	These terminals connect to a harmonic filter module.
V		
W		
X	Input AC reactor 1 outputs	These terminals connect to D1000.
Y		
Z		

[CIMR-DA4A0270 to 4A0630]

Input AC Reactor 1

Terminal	Type	Function
U	Input AC reactor 1 inputs	These terminals connect to the input AC reactor 2 and the reactor for the harmonic filter.
V		
W		
X	Input AC reactor 1 outputs	These terminals connect to D1000.
Y		
Z		

Input AC Reactor 2

Terminal	Type	Function
U	Input AC reactor 2 inputs	These terminals connect to the power supply.
V		
W		
X	Input AC reactor 2 outputs	These terminals connect to the input AC reactor 2 and the reactor for the harmonic filter.
Y		
Z		

Reactor for Harmonic Filter

Terminal	Type	Function
U	Reactor inputs for harmonic filter	These terminals connect to the input AC reactor 1 and the input AC reactor 2.
V		
W		
X	Reactor outputs for harmonic filter	These terminals connect to the capacitor for the harmonic filter.
Y		
Z		

Capacitor for Harmonic Filter

Terminal	Type	Function
U	Capacitor inputs for harmonic filter	These terminals connect to the capacitor for the harmonic filter.
V		
W		
E	Grounding terminal	Grounding terminals For 200 V class: 100 Ω or less For 400 V class: 10 Ω or less

Dimensions

D1000 Energy-saving Unit

Enclosures

Enclosures of standard products vary depending on the model. Refer to the table below.

Voltage Class		200 V Class								400 V Class											
Model CIMR-DA:A:.....		0005	0010	0020	0030	0050	0065	0090	0130	0005	0010	0020	0030	0040	0060	0100	0130	0185	0270	0370	0630
Rated Output Capacity kW		5	10	20	30	50	65	90	130	5	10	20	30	40	60	100	130	185	270	370	630
Open-Chassis	IP00	-		Standard						-		Standard									
	IP20	Standard		Made to order						Standard		Made to order				Not available					

* : This number indicates the voltage class (2: 200 V class, 4: 400 V class).

Open-Chassis [IP00]

Dimensions (mm)

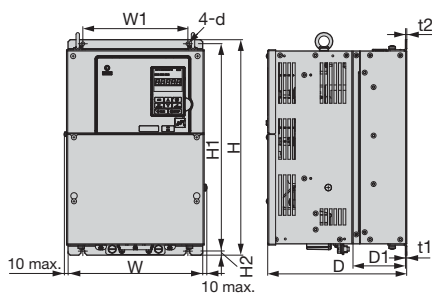

Figure 1

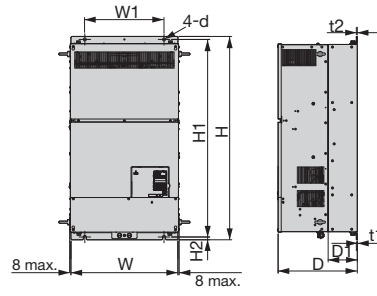

Figure 2

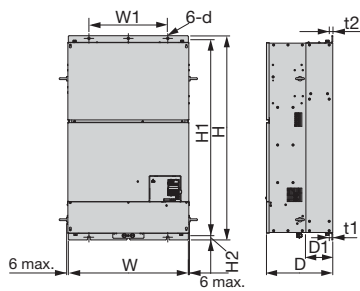

Figure 3

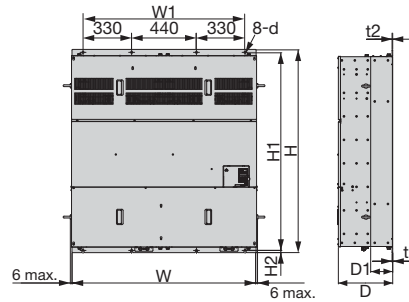

Figure 4

200 V Class

Model CIMR-DA2A:.....	Rated Output Capacity kW	Figure	Dimensions (mm)										Weight (kg)	Cooling
			W	H	D	W1	H1	H2	D1	t1	t2	d		
0030	30	1	275	450	258	220	435	7.5	100	2.3	2.3	M6	20	Fan cooled
0050	50		325	550	283	260	535	7.5	110	2.3	2.3		32	
0065	65		450	705	330	325	680	12.5	130	3.2	3.2		M10	
0090	90		61											
0130	130	2	500	800	350	370	773	13	130	4.5	4.5	M12	85	

400 V Class

Model CIMR-DA4A:.....	Rated Output Capacity kW	Figure	Dimensions (mm)										Weight (kg)	Cooling	
			W	H	D	W1	H1	H2	D1	t1	t2	d			
0030	30	1	275	450	258	220	435	7.5	100	2.3	2.3	M6	21	Fan cooled	
0040	40		325	550	283	260	535	7.5	110	2.3	2.3		M6		34
0060	60		36												
0100	100		85												
0130	130	2	500	800	350	370	773	13	130	4.5	4.5	M12	85		
0185	185	3	670	1140	370	440	1110	15	150	4.5	4.5	M12	183		
0270	270		194												
0370	370		413												
0630	630	4	1250	1380	370	1100	1345	15	150	4.5	4.5	M12	413		

■ Open-Chassis [IP20]
Dimensions (mm)

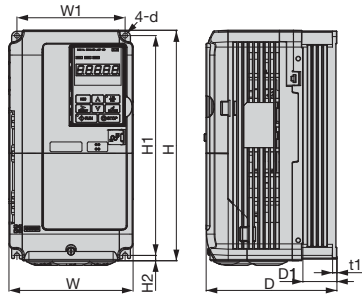

Figure 1

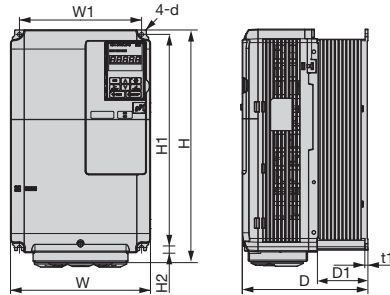

Figure 2

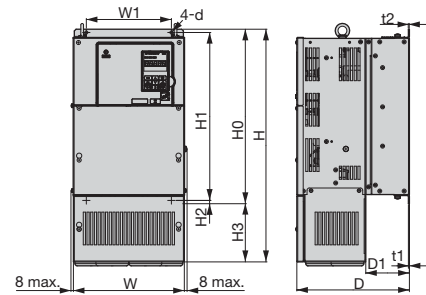

Figure 3

200 V Class

Model CIMR-DA2A	Rated Output Capacity kW	Figure	Dimensions (mm)												Weight (kg)	Cooling
			W	H	D	W1	H0	H1	H2	H3	D1	t1	t2	d		
0005	5	1	180	300	187	160	–	284	8	–	75	5	–	M5	5	Fan cooled
0010	10		220	365	197	192	350	335	8	15	78	5	–	M6	8	
0020	20	2	279	515	258	220	450	435	7.5	65	100	2.3	2.3	M6	23	
0030	30		329	730	283	260	550	535	7.5	180	110	2.3	2.3	M6	36	
0050	50	3	456	960	330	325	705	680	12.5	255	130	3.2	3.2	M10	65	
0065	65		504	1168	350	370	800	773	13	368	130	4.5	4.5	M12	69	
0090	90		504	1168	350	370	800	773	13	368	130	4.5	4.5	M12	95	
0130	130															

400 V Class

Model CIMR-DA4A	Rated Output Capacity kW	Figure	Dimensions (mm)												Weight (kg)	Cooling
			W	H	D	W1	H0	H1	H2	H3	D1	t1	t2	d		
0005	5	1	180	300	187	160	–	284	8	–	75	5	–	M5	5	Fan cooled
0010	10		220	365	197	192	–	335	8	–	78	5	–	M6	8	
0020	20	2	279	515	258	220	450	435	7.5	65	100	2.3	2.3	M6	23	
0030	30		329	730	283	260	550	535	7.5	180	110	2.3	2.3	M6	38	
0040	40	3	456	960	330	325	705	680	12.5	255	130	3.2	3.2	M10	40	
0060	60		504	1168	350	370	800	773	13	368	130	4.5	4.5	M12	95	
0100	100		504	1168	350	370	800	773	13	368	130	4.5	4.5	M12	95	
0130	130															
0185	185															

Features
Application Examples
Applicable Models
Standard Specifications
Selecting the Capacity
Connection Diagram
Terminal Functions
Dimensions
Fully-Enclosed Design
Peripheral Devices and Options
Application Notes
Global Service Network

Combinations of Standard Configuration Devices

● Standard Configuration Devices

The standard configuration devices depend on D1000 model. Use the following table to select a combination.

Voltage Class	200 V Class								400 V Class											
	0005	0010	0020	0030	0050	0065	0090	0130	0005	0010	0020	0030	0040	0060	0100	0130	0185	0270	0370	0630
Harmonic Filter Module	●	●	●	●	●	●	●	●	●	●	●	●	●	●	●	●	●	—	—	—
Input AC Reactor 1	●	●	●	●	●	●	●	●	●	●	●	●	●	●	●	●	●	●	●	●
Input AC Reactor 2	—	—	—	—	—	—	—	—	—	—	—	—	—	—	—	—	—	●	●	●
Reactor for Harmonic Filter	—	—	—	—	—	—	—	—	—	—	—	—	—	—	—	—	—	●	●	●
Condenser for Harmonic Filter	—	—	—	—	—	—	—	—	—	—	—	—	—	—	—	—	—	●	●	●

* : This number indicates the voltage class (2: 200 V class, 4: 400 V class).

● Input AC Reactor 1 (UZBA-B: for Input)

Select the reactor according to the capacity of D1000.

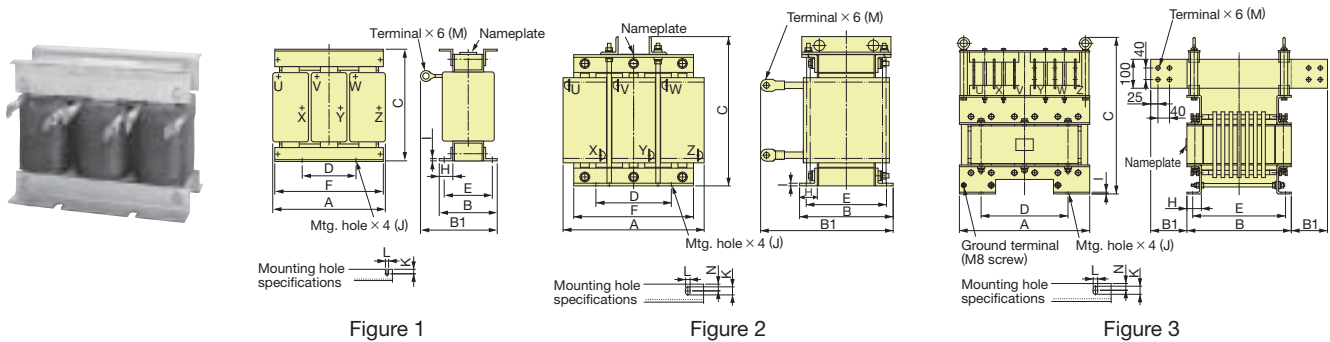

Input AC Reactor 1 200 V Class

Model CIMR-DA2A	Code No.	Qty.	Figure	Dimensions (mm)														Weight (kg)	
				A	B	B1	C	D	E	F	H	I	J	K	L	M	N		
0005	100-088-216	1	1	160	114	172	133	75	95	160	25	2.3	M6	10	7	M4	—	8.2	
0010	100-088-217			205	106	173	173	75	85	205	25	3.2	M6	10	7	M5	—	14	
0020	100-088-218		2	1	268	146	241	275	150	115	220	40	6	M8	18	10	M6	15	28
0030	100-088-219				268	161	260	290	150	131	220	40	6	M8	18	10	M8	15	38
0050	100-088-220		2	2	330	161	268	334	170	131	270	40	6	M10	22	12	M8	15	65
0065	100-088-221				320	211	306	343	170	181	270	40	6	M10	22	12	M12	15	79
0090	100-088-222		2	2	380	220	320	382	200	180	320	50	6	M12	27	15	M12	20	102
0130	100-088-223				445	240	386	436	240	200	420	50	6	M12	27	15	M12	20	164

400 V Class

Model CIMR-DA4A	Code No.	Qty.	Figure	Dimensions (mm)														Weight (kg)	
				A	B	B1	C	D	E	F	H	I	J	K	L	M	N		
0005	100-088-224	1	1	160	104	162	133	75	85	160	25	2.3	M6	10	7	M4	—	7.1	
0010	100-088-225			206	101	166	173	75	80	205	25	3.2	M6	10	7	M4	—	13	
0020	100-088-226		2	1	240	126	210	212	150	106	240	25	3.2	M8	10	10	M6	—	26
0030	100-088-227				265	161	243	290	150	131	220	40	6	M8	18	10	M8	15	34
0040	100-088-228		2	2	268	176	272	285	150	146	220	40	6	M8	18	10	M8	15	44
0060	100-088-229				330	161	273	331	170	131	270	40	6	M10	22	12	M8	15	56
0100	100-088-230		2	2	320	211	309	366	170	181	270	40	6	M10	22	12	M8	15	87
0130	100-088-231				385	235	330	382	200	195	320	50	6	M12	27	15	M12	20	122
0185	100-088-232	2	2	450	240	335	424	240	200	420	50	6	M12	27	15	M12	20	150	
0270	100-088-233			510	300	410	482	245	250	490	65	6	M12	27	15	M12	25	222	
0370	100-088-234	2	2	560	320	435	549	300	260	530	75	9	M12	27	15	M12	30	293	
0630	100-088-234			560	320	435	549	300	260	530	75	9	M12	27	15	M12	30	293	

Input AC Reactor 2 400 V Class

Model CIMR-DA4A	Code No.	Qty.	Figure	Dimensions (mm)														Weight (kg)
				A	B	B1	C	D	E	F	H	I	J	K	L	M	N	
0270	100-088-235	1	2	330	176	325	326	170	146	270	40	6	M10	22	12	M12	15	60
0370	100-088-236			385	220	350	382	200	180	320	50	6	M12	27	15	M12	20	102
0630	100-088-237		452	375	130	545	302	335	—	50	6	M12	27	15	M12	20	172	

● Harmonic Filter Module

Select the appropriate harmonic filter modules according to D1000 models.

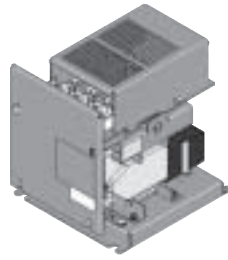

Dimensions (mm)

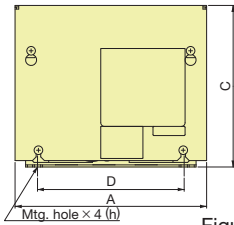

Figure 4

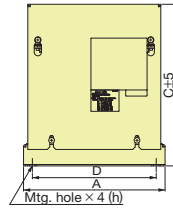
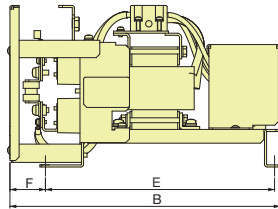

Figure 5

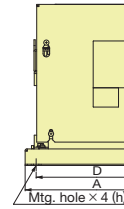
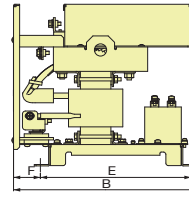

Figure 6

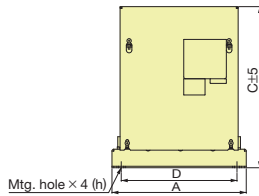
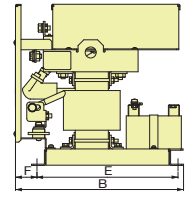

Figure 7

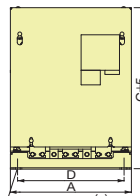
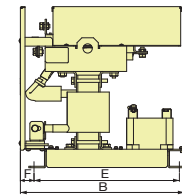

Figure 8

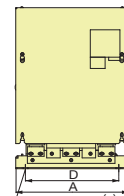
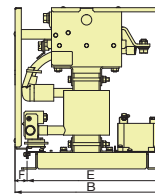
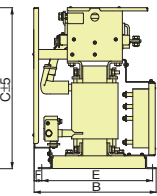

Figure 9



200 V Class

Model CIMR-DA2A	Harmonic Filter Module		Figure	Dimensions (mm)							Weight (kg)
	Model	Code No.		A	B	C	D	E	F	H	
0005	EUJ710801	100-115-243	4	209	285	176	160	240	39	M6	6.5
0010	EUJ710810	100-091-897	4	209	295	184	160	250	39	M6	9
0020	EUJ710820	100-091-898	5	232	301	265	203	247	44	M8	14
0030	EUJ710831	100-115-244	6	260	305	281	220	256	39	M8	16
0050	EUJ710840	100-091-915	7	290	355	348	250	314	30	M10	27
0065	EUJ710851	100-115-249	8	290	352	350	254	314	27	M10	38
0090	EUJ710861	100-115-250	8	290	352	387	254	314	27	M10	43
0130	EUJ710871	100-110-486	9	350	380	500	290	350	19	M10	62

Condenser for Harmonic Filter Dimensions (mm)

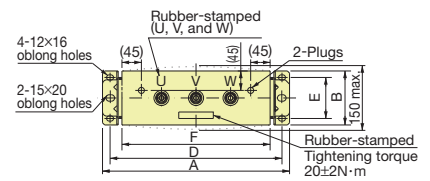

400 V Class

Model CIMR-DA4A	Harmonic Filter Module		Figure	Dimensions (mm)							Weight (kg)
	Model	Code No.		A	B	C	D	E	F	H	
0005	EUJ710880	100-106-328	4	209	285	176	160	240	39	M6	7
0010	EUJ710890	100-106-329	4	209	295	178	160	250	39	M6	9
0020	EUJ710900	100-106-330	5	232	301	265	203	247	44	M8	15
0030	EUJ710911	100-115-245	6	260	305	293	220	256	39	M8	17
0040	EUJ710921	100-115-246	6	260	305	293	220	256	39	M8	19
0060	EUJ710931	100-115-247	7	290	355	348	250	314	30	M10	27
0100	EUJ710941	100-115-248	7	290	355	385	250	314	30	M10	39
0130	EUJ710951	100-110-487	9	350	380	500	290	350	19	M10	64
0185	EUJ710961	100-110-488	9	350	380	500	290	344	25	M10	73

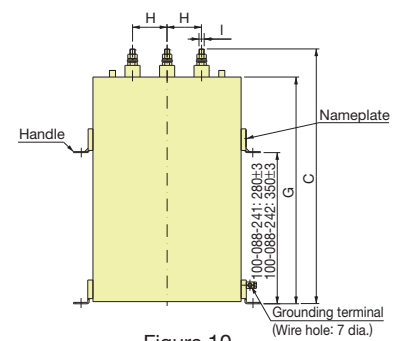

Figure 10

● Reactor for Harmonic Filter, Condenser for Harmonic Filter

Reactor for Harmonic Filter

Model CIMR-DA4A	Code No.	Figure	Dimensions (mm)											Weight (kg)		
			A	B	B1	C	D	E	F	H	I	J	K		L	M
0270	100-088-238	1	160	104	147	135	75	85	160	25	2.3	M6	10	7	M8	6.3
0370	100-088-239		180	100	155	150	75	80	180	25	2.3	M6	10	7	M8	7.6
0630	100-088-240		210	102	171	190	75	80	205	25	3.2	M6	12	7	M10	12

Condenser for Harmonic Filter

Model CIMR-DA4A	Code No.	Figure	Dimensions (mm)								Weight (kg)		
			A	B	C	D	E	F	G	H		H1	I
0270	100-088-241	10	438	128	502	398±3	95±2	345	433	80±5	—	M12	27
0370	100-088-242		438	128	602	398±3	95±2	345	533	80±5	—	M12	33
0630	100-088-243	11	695	128	582	655±3	95±2	602	513	80±5	60±5	M12	55

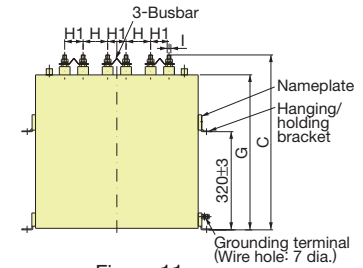
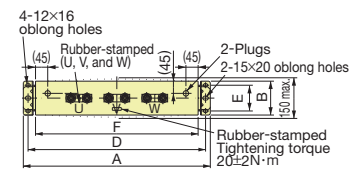

Figure 11

- Features
- Application Examples
- Applicable Models
- Standard Specifications
- Selecting the Capacity
- Connection Diagram
- Terminal Functions
- Dimensions
- Fully-Enclosed Design
- Peripheral Devices and Options
- Application Notes
- Global Service Network

Fully-Enclosed Design

An Open-Chassis model can be installed in a fully-enclosed panel.

An open-chassis model in a protective enclosure with the heatsink inside the panel allows for an intake air temperature of up to 50°C. The heatsink can alternatively be mounted outside the enclosure panel. This reduces the amount of heat inside the panel and requires less space for installation. In this case, an intake air temperature of up to 40°C is allowed. Current derating or other steps to ensure cooling are required at 50°C.

- Cooling Design for Fully-Closed Enclosure Panel
- Mounting the External Heatsink
- Ventilation Space

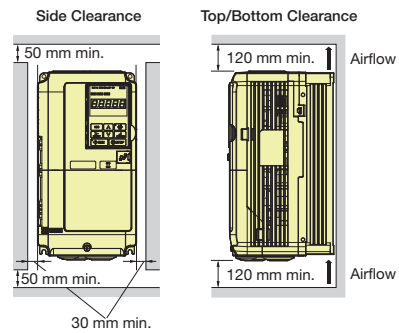
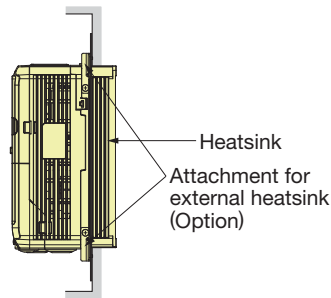
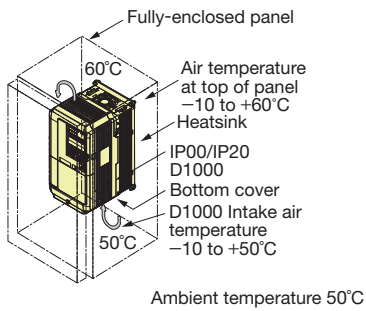

If you use a D1000 of 30 kW or larger with a 200 or 400 V class mounted in a panel, provide space for the hoisting eye bolts on both sides of the unit and for main circuit wiring.

Watt Loss Data

D1000 Energy-saving Unit

200 V Class

Model CIMR-DA2A:○○○○○		0005	0010	0020	0030	0050	0065	0090	0130
Rated Output Capacity	kW	5	10	20	30	50	65	90	130
Rated Output Current	A	15	30	61	91	152	197	273	394
Heat Loss W	Heatsink	93	167	319	380	666	1193	1616	1918
	Internal	38	57	101	134	245	464	619	776
	Total Heat Loss	131	224	420	514	911	1657	2235	2694

400 V Class

Model CIMR-DA4A:○○○○○		0005	0010	0020	0030	0040	0060	0100	0130	0185	0270	0370	0630
Rated Output Capacity	kW	5	10	20	30	40	60	100	130	185	270	370	630
Rated Output Current	A	8	15	30	45	61	91	152	197	280	409	561	955
Heat Loss W	Heatsink	83	158	314	263	647	1092	1303	1969	2864	2477	3705	6103
	Internal	37	58	103	109	201	334	467	695	997	1323	1852	3098
	Total Heat Loss	120	216	417	372	848	1426	1770	2664	3861	3800	5557	9201

Standard Configuration Devices

200 V Class

Model CIMR-DA2A:○○○○○		0005	0010	0020	0030	0050	0065	0090	0130
Heat Loss W	Harmonic Filter Module	32	55	80	89	122	133	156	265
	Input AC Reactor 1	80	120	225	270	365	540	665	875

400 V Class

Model CIMR-DA4A:○○○○○		0005	0010	0020	0030	0040	0060	0100	0130	0185	0270	0370	0630
Heat Loss W	Harmonic Filter Module	37	57	77	84	96	158	216	272	365	-	-	-
	Input AC Reactor 1	75	100	145	285	290	375	580	610	1065	1205	1305	2610
	Input AC Reactor 2	-	-	-	-	-	-	-	-	-	365	460	735
	Reactor for Harmonic Filter	-	-	-	-	-	-	-	-	-	45	55	90
	Condenser for Harmonic Filter	-	-	-	-	-	-	-	-	-	29	41	111

● Attachment for External Heatsink

Additional attachments are required for D1000 with model numbers CIMR-DA2A0005 to 0020, CIMR-DA4A0005 to 0020. The final product will be wider and taller than the unit.
 Additional attachments are not required for CIMR-DA2A0030 and above, and CIMR-DA4A0030 and above.
 Note: Contact Yaskawa for information on attachments for earlier models.

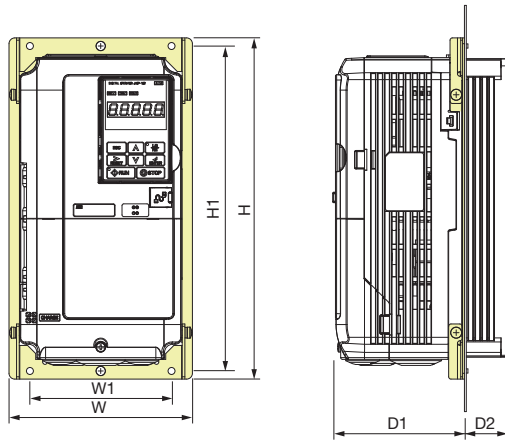

200 V Class

Model CIMR-DA2A	Dimensions (mm)						Code No.
	W	H	W1	H1	D1	D2	
0005	198	329	160	315	112	73.4	EZZ020800C
0010	198	329	160	315	112	73.4	EZZ020800C
0020	238	380	192	362	119	76.4	EZZ020800D

400 V Class

Model CIMR-DA4A	Dimensions (mm)						Code No.
	W	H	W1	H1	D1	D2	
0005	198	329	160	315	112	73.4	EZZ020800C
0010	198	329	160	315	112	73.4	EZZ020800C
0020	238	380	192	362	119	76.4	EZZ020800D

● Panel Modification for External Heatsink

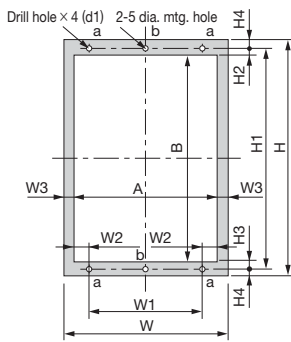

Modification Figure 1

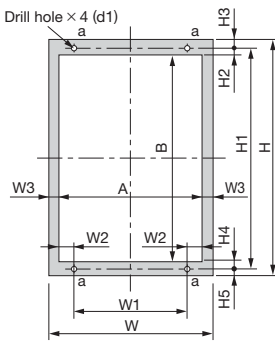

Modification Figure 2

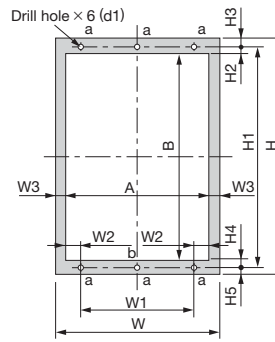

Modification Figure 3

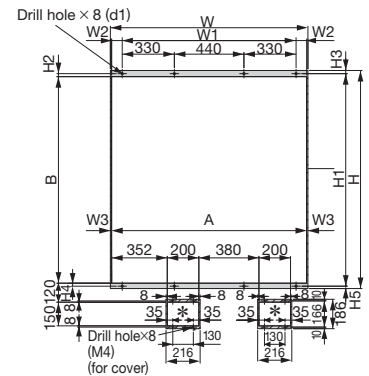

Modification Figure 4

* : Panel opening needed to replace an air filter installed to the bottom of the D1000. The opening should be kept as small as possible.

200 V Class

Model CIMR-DA2A	Modification Figure	Dimensions (mm)												
		W	H	W1	W2	W3	H1	H2	H3	H4	H5	A	B	d1
0005	1	198	329	160	10	9	315	17.5	10.5	7	—	180	287	M5
0010		238	380	192	14	9	362	13	8	9	—	220	341	M6
0020		275	450	220	19.5	8	435	8	7.5	8	7.5	259	419	M6
0030	2	325	550	260	24.5	8	535	8	7.5	8	7.5	309	519	M6
0050		450	705	325	54.5	8	680	12.5	12.5	12.5	12.5	434	655	M10
0065		500	800	370	57	8	773	16	14	17	13	484	740	M12
0090		500	800	370	57	8	773	16	14	17	13	484	740	M12
0130	500	800	370	57	8	773	16	14	17	13	484	740	M12	

400 V Class

Model CIMR-DA4A	Modification Figure	Dimensions (mm)												
		W	H	W1	W2	W3	H1	H2	H3	H4	H5	A	B	d1
0005	1	198	329	160	10	9	315	17.5	10.5	7	—	180	287	M5
0010		238	380	192	14	9	362	13	8	9	—	220	341	M6
0020		275	450	220	19.5	8	435	8	7.5	8	7.5	259	419	M6
0030	2	325	550	260	24.5	8	535	8	7.5	8	7.5	309	519	M6
0040		450	705	325	54.5	8	680	12.5	12.5	12.5	12.5	434	655	M10
0060		500	800	370	57	8	773	16	14	17	13	484	740	M12
0100		500	800	370	57	8	773	16	14	17	13	484	740	M12
0130	3	670	1140	440	107	8	1110	19	15	19	15	654	1072	M12
0185		670	1140	440	107	8	1110	19	15	19	15	654	1072	M12
0270		670	1140	440	107	8	1110	19	15	19	15	654	1072	M12
0370	4	1250	1380	1100	67	8	1345	19	20	19	15	1234	1307	M12
0630		1250	1380	1100	67	8	1345	19	20	19	15	1234	1307	M12

Features

Application Examples

Applicable Models

Standard Specifications

Selecting the Capacity

Connection Diagram

Terminal Functions

Dimensions

Fully-Enclosed Design

Peripheral Devices and Options

Application Notes

Global Service Network

Peripheral Devices and Options

Peripheral Devices

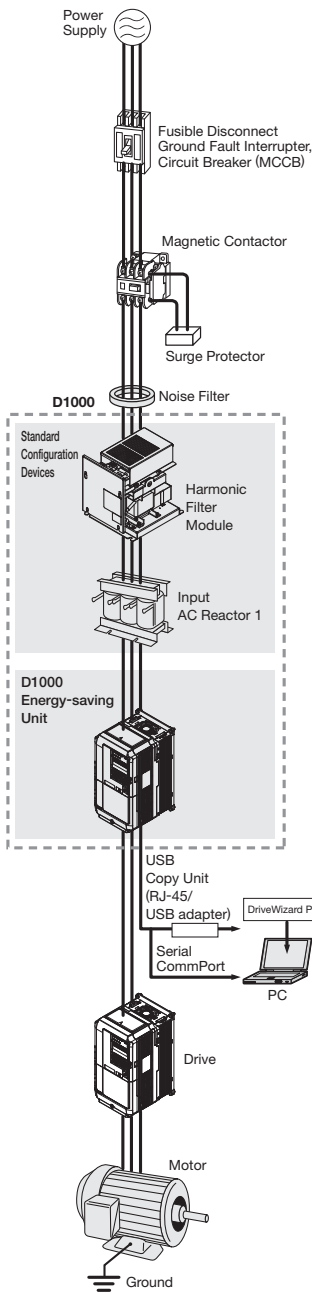

Name	Purpose	Model, Manufacturer	Page
Ground Fault Interrupter (GFI)	Always install a GFI on the power-supply side to protect the power supply system and to prevent an overload at the occurrence of shortcircuit, and to protect the drive from ground faults that could result in electric shock or fire. Note: When a GFI is installed for the upper power supply system, an MCCB can be used instead of a GFI. (Choose a GFI designed to minimize harmonics specifically for energy-saving units. Use one GFI per energy-saving unit, each with a current rating of at least 30 mA.)	NV series* by Mitsubishi Electric Corporation NS Series* by Schneider Electric	26
Circuit Breaker	Always install a circuit breaker on the power-supply side to protect the power supply system and to prevent an overload at the occurrence of a short-circuit.	NF series* by Mitsubishi Electric Corporation	26
Magnetic Contactor	Interrupts the power supply to the drive. In addition to protecting drive circuitry, a magnetic contactor also prevents damage to a braking resistor if used.	SC series* by Fuji Electric FA Components & Systems Co., Ltd	26
Surge Protector	Absorbs the voltage surge from switching of electro-magnetic contactors and control relays. Install a surge protector to the magnetic contactors and control relays as well as magnetic valves and magnetic braking coil.	DCR2 series RFN series by Nippon Chemicon Corporation	26
Noise Filter (Zero Phase Reactor)	Reduces noise from the line that enters into the input power system of energy-saving unit should be installed as close as possible to D1000. Can be used on both the input and output sides.	F6045GB F11080GB by Hitachi Metals, Ltd.	27

* : Recommended by Yaskawa. Contact the manufacturer in question for availability and specifications of non-Yaskawa products.

Options

Name	Purpose	Model, Manufacturer	Page
24 V Power Supply	Provides power supply for the control circuit and option boards. Note: Parameter settings cannot be changed when the drive is operating solely from this power supply.	PS-A10LB (200 V class) PS-A10HB (400 V class)	27
USB Copy Unit (RJ-45/USB compatible plug)	· Can copy parameter settings easily and quickly to be later transferred to another drive. · Adapter for connecting D1000 to the USB port of a PC.	JVOP-181	29
PC Cable	Connect D1000 and PC when using DriveWizard Plus. The cable length must be 3 m or less.	Commercially available USB2.0 A/B cable.	29
LCD Operator	For easier operation when using the optional LCD operator. Allows for remote operation. Includes a Copy function for saving the settings of D1000.	JVOP-180	28
LCD Operator Extension Cable	Cable for connecting the LCD operator.	WV001 : 1 m WV003 : 3 m	28
Attachment for External Heatsink	Required for heatsink installation. Note: Current derating may be needed when using a heatsink.	—	23

Option Cards

Type	Name	Model	Function	Manual No.
Built-in Type (connected to connector)	Communications Option Card	MECHATROLINK-II Interface	SI-T3 Used for running or stopping the D1000, setting or referencing parameters, and monitoring input current, output voltage, or similar items through MECHATROLINK-II communication with the host controller.	TOBPC73060050 SIEPC73060061
		CC-Link Interface	Available soon Used for running or stopping the D1000, setting or referencing parameters, and monitoring input current, output voltage, or similar items through CC-Link communication with the host controller.	—
		DeviceNet Interface	Available soon Used for running or stopping the D1000, setting or referencing parameters, and monitoring input current, output voltage, or similar items through DeviceNet communication with the host controller.	—
		PROFIBUS-DP Interface	Available soon Used for running or stopping the D1000, setting or referencing parameters, and monitoring input current, output voltage, or similar items through PROFIBUS-DP communication with the host controller.	—
		CANopen Interface	Available soon Used for running or stopping the D1000, setting or referencing parameters, and monitoring input current, output voltage, or similar items through CANopen communication with the host controller.	—
	Monitor Option Card	Analog Monitor	AO-A3 Outputs analog signal for monitoring the output state (input frequency, output voltage etc.) of the D1000. · Output resolution: 11 bit signed (1/2048) · Output voltage: 0 to 10 Vdc (non-isolated) · Terminals: 2 analog outputs	TOBPC73060040
		Digital Output	DO-A3 Outputs isolated type digital signal for monitoring the run state of the D1000 (alarm signal, during run, etc.) · Terminals: 6 photocoupler outputs (48 V, 50 mA or less) 2 relay contact outputs (250 Vac, 1 A or less 30 Vdc, 1 A or less)	TOBPC73060041

Note: 1. Each communication option card requires a separate configuration file to link to the network.
2. The option cards are RoHS compliant.

Features

Application Examples

Applicable Models

Standard Specifications

Selecting the Capacity

Connection Diagram

Terminal Functions

Dimensions

Fully-Enclosed Design

Peripheral Devices and Options

Application Notes

Global Service Network

Peripheral Devices and Options (continued)

● Ground Fault Interrupter, Circuit Breaker, Magnetic Contactor

Select these devices according to the model of D1000.



Ground Fault Interrupter
【Mitsubishi Electric Corporation】



Circuit Breaker
【Mitsubishi Electric Corporation】



Magnetic Contactor
【Fuji Electric FA Components & Systems Co., Ltd】

Wiring a Magnetic Contactor in Parallel

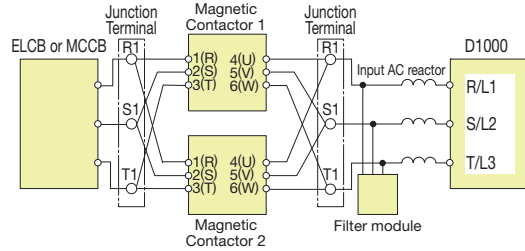

Note: When wiring contactors in parallel, make sure wiring lengths are the same to keep current flow even by installing junctions.

200 V Class

D1000 Model	Ground Fault Interrupter			Circuit Breaker			Magnetic Contactor	
CIMR-DA2A	Model	Rated Current (A)	Interrupt Capacity (kA) Icu/Ics*1	Model	Rated Current (A)	Interrupt Capacity (kA) Icu/Ics*1	Model	Rated Current (A)
0005	NV32-SV	20	10/10	NF32-SV	20	7.5/7.5	SC-N1	26
0010	NV63-SV	50	15/15	NF63-SV	50	15/15	SC-N2S	50
0020	NV125-SV	100	50/50	NF125-SV	100	50/50	SC-N4	80
0030	NV250-SV	150	85/85	NF250-SV	150	85/85	SC-N6	125
0050	NV250-SV	225	85/85	NF250-SV	225	85/85	SC-N8	180
0065	NV400-SW	300	85/85	NF400-SW	300	85/85	SC-N11	300
0090	NV400-SW	400	85/85	NF400-SW	400	85/85	SC-N12	400
0130	NV630-SW	600	85/85	NF630-SW	600	85/85	SC-N14	600

400 V Class

D1000 Model	Ground Fault Interrupter			Circuit Breaker			Magnetic Contactor	
CIMR-DA4A	Model	Rated Current (A)	Interrupt Capacity (kA) Icu/Ics*1	Model	Rated Current (A)	Interrupt Capacity (kA) Icu/Ics*1	Model	Rated Current (A)
0005	NV32-SV	15	5/5	NF32-SV	15	2.5/2.5	SC-4-1	17
0010	NV32-SV	30	5/5	NF32-SV	30	2.5/2.5	SC-N2	32
0020	NV63-SV	50	7.5/7.5	NF63-SV	50	7.5/7.5	SC-N2S	48
0030	NV125-SV	75	25/25	NF125-SV	75	25/25	SC-N4	80
0040	NV125-SV	100	25/25	NF125-SV	100	25/25	SC-N4	80
0060	NV250-SV	150	36/36	NF250-SV	150	36/36	SC-N6	110
0100	NV250-SV	225	36/36	NF250-SV	225	36/36	SC-N8	180
0130	NV400-SW	300	42/42	NF400-SW	300	42/42	SC-N11	300
0185	NV400-SW	400	42/42	NF400-SW	400	42/42	SC-N12	400
0270	NV630-SEW	630	42/42	NF630-SW	630	42/42	SC-N14	600
0370	NV800-SEW	800	42/42	NF800-SEW	800	42/42	SC-N16	800
0630	NS1600H*2	1600	70	NF1600-SEW	1600	85/43	SC-N16×2*3	800*4

- *1 : Icu: Rated ultimate short-circuit breaking capacity Ics: Rated service short-circuit breaking capacity
- *2 : NS series by Schneider Electric.
- *3 : When two units are connected in parallel.
- *4 : Rated current for a single unit.

● Surge Protector

Dimensions (mm)

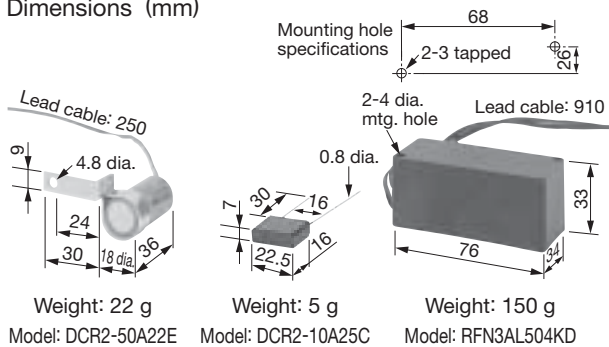

Product Line

Surge Protector		Model	Specifications	Code No.
200 V to 230 V	Large-Capacity Coil (other than relay)	DCR2-50A22E	220 Vac 0.5 μF+200 Ω	C002417
200 V to 240 V	Control Relay	MY2, MY3 [Omron Corporation] MM2, MM4 [Omron Corporation] HH22, HH23 [Fuji Electric FA Components & Systems Co., Ltd]	250 Vac 0.1 μF+100 Ω	C002482
380 to 480 V		RFN3AL504KD	1000 Vdc 0.5 μF+220 Ω	C002630

【Nippon Chemi-Con Corporation】

● Noise Filter (Zero Phase Reactor)

Select the zero-phase reactor in accordance with the wire gauge used for D1000.*

* : Current values for wire gauges may vary based on electrical codes. The following table lists recommended wire gauges based on Japanese electrical standards and Yaskawa's Normal duty (ND) rating. Contact Yaskawa for details regarding wire and UL standards.

FINEMET Zero-Phase Reactor to Reduce Radio Noise

Note: FINEMET is a registered trademark of Hitachi Metals, Ltd.



[Hitachi Metals, Ltd.]

Connection Diagram

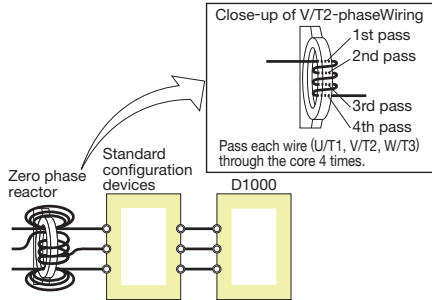
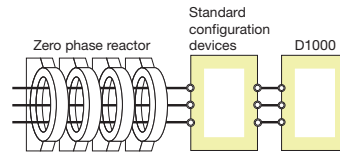
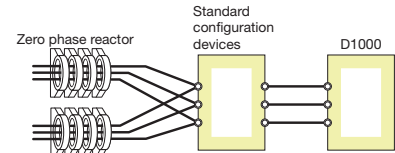

Diagram a



All wires (X, Y, Z) should pass through the four cores of the reactor in series without winding.

Diagram b



Separate each terminal lead for X, Y, and Z in half, passing one half of the wires through a set of four cores and the other half through the other set of four cores as shown.

Diagram c

Dimensions (mm)

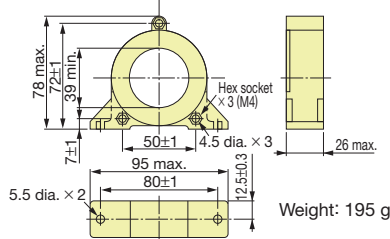

Model F6045GB

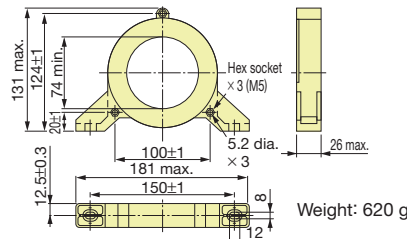

Model F11080GB

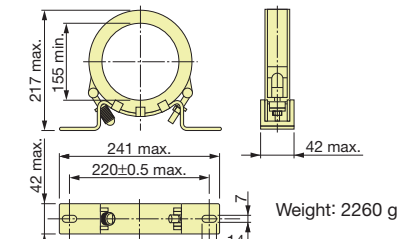

Model F200160PB

200 V Class

D1000		Noise Filter (Zero Phase Reactor)			
Model	Recommended Gauge (mm ²)	Model	Code No.	Qty.	Diagram
CIMR-DA2A: 0005	2	F6045GB	FIL001098	1	a
0010	5.5				
0020	14				
0030	38				
0050	60	F11080GB	FIL001097	4	b
0065	80×2P				
0090	80×2P				
0130	100×2P	F200160PB	300-001-041	4	b

400 V Class

D1000		Noise Filter (Zero Phase Reactor)			
Model	Recommended Gauge (mm ²)	Model	Code No.	Qty.	Diagram
CIMR-DA4A: 0005	1.25	F6045GB	FIL001098	1	a
0010	2				
0020	8	F6045GB	FIL001098	4	b
0030	14				
0040	14				
0060	38	F11080GB	FIL001097	4	b
0100	60				
0130	80×2P				
0185	80×2P				
0270	60×2P	F200160PB	300-001-041	4	b
0370	100×2P				
0630	100×4P				

● 24 V Power Supply

The 24 V Power Supply Option maintains D1000 control circuit power in the event of a main power outage. The control circuit keeps the network communications and I/O data operational in the event of a power outage. It supplies external power to the control circuit only.

Note: Even if a back-up power supply is used for the control circuit, the main circuit must still have power in order to change parameter settings.

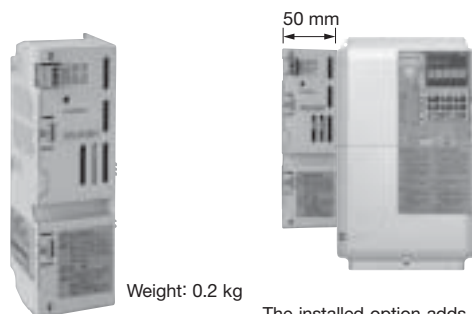

Weight: 0.2 kg

The installed option adds 50 mm to the total width of D1000. Installed internally for models CIMR-D: 4A0270 to 4A0630.

Connection Diagram

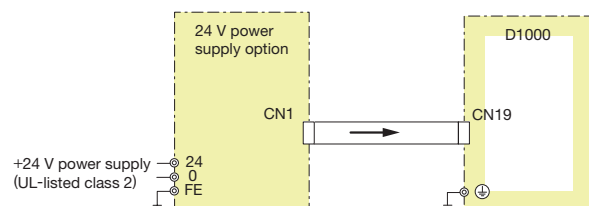

Model	Code No.
200 V Class: PS-A10LB	PS-A10LB
400 V Class: PS-A10HB	PS-A10HB

Peripheral Devices and Options (continued)

LCD Operator

An LCD operator with a 6-digit display makes it easy to check the necessary information. Includes a copy function for saving drive settings.

Model	Code No.
JVOP-180	100-041-022

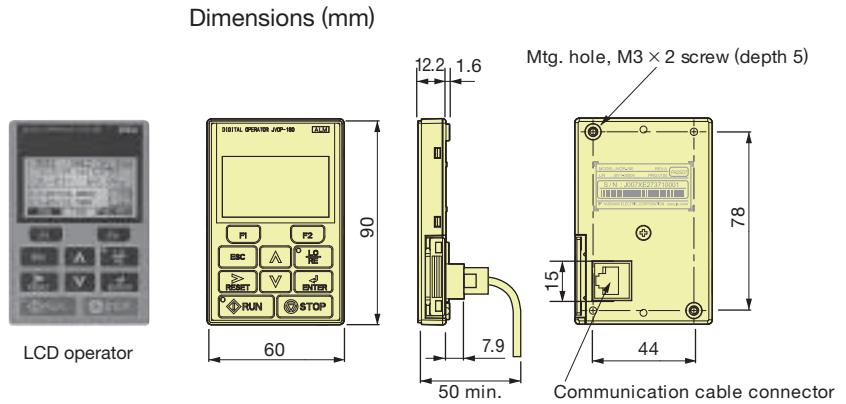

Operator Extension Cable

Enables remote operation.

Model	Code No.
WV001 (1 m)	WV001
WV003 (3 m)	WV003

Note: Do not use this cable for connecting the unit to a PC. Failure to comply may cause damage to the PC.

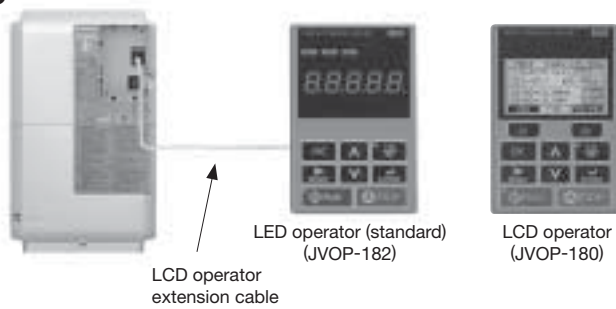

Operator Mounting Bracket

This bracket is required to mount the LED or LCD operator outside an enclosure panel.

Item	Model	Code No.	Installation	Notes
<p>Installation Support Set A</p>	EZZ020642A	100-039-992	<p>M4 × 10 truss head screw</p> <p>M3 × 6 pan head screw</p> <p>13.9</p> <p>min. 50</p>	For use with holes through the panel
<p>Installation Support Set B</p>	EZZ020642B	100-039-993	<p>M4 nut</p> <p>M3 × 6 pan head screw</p> <p>13.9</p> <p>min. 50</p>	<p>For use with panel mounted threaded studs</p> <p>Note: If weld studs are on the back of the panel, use the Installation Support Set B.</p>

● USB Copy Unit (Model: JVOP-181)

Copy parameter settings in a single step, and then transfer those settings to another D1000.
Connects to the RJ-45 port on the D1000 and to the USB port on a PC.

Connection

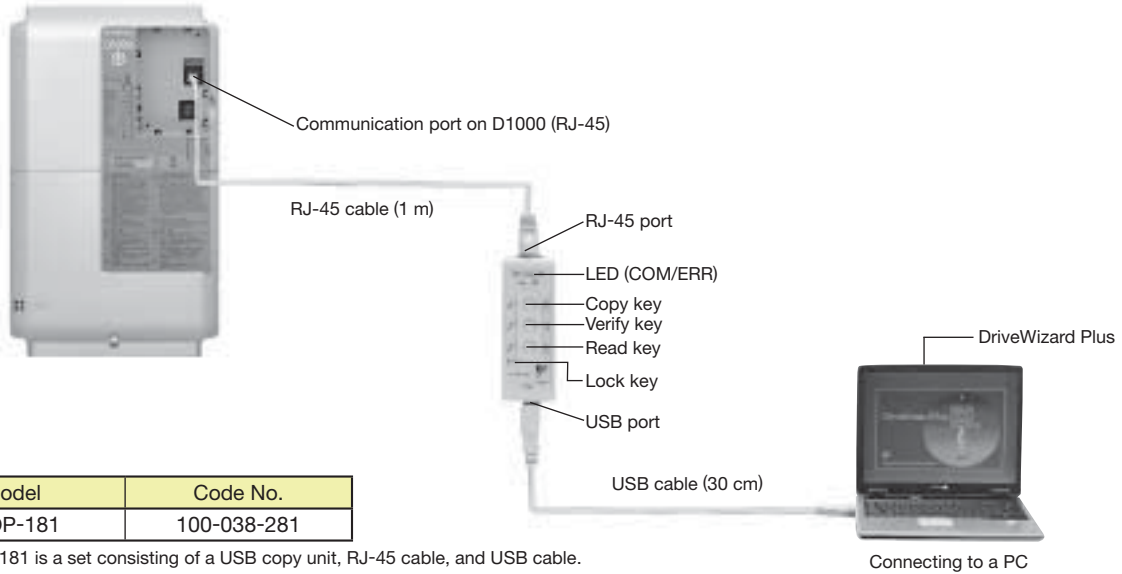

Model	Code No.
JVOP-181	100-038-281

Note: JVOP-181 is a set consisting of a USB copy unit, RJ-45 cable, and USB cable.

Specifications

Item	Specifications
Port	LAN (RJ-45) Connect to the D1000. USB (Ver.2.0 compatible) Connect to the PC as required.
Power Supply	Supplied from a PC or the D1000.
Operating System	Windows2000/XP
Memory	Memorizes the parameters for one D1000.
Dimensions	30 (W)×80 (H)×20 (D) mm
Accessories	RJ-45 Cable (1 m), USB Cable (30 cm)

- Note: 1. Parameters can only be saved to the D1000 when the voltage class, capacity, control mode, and software version match.
2. Requires a driver for the USB copy unit JVOP-181.
You can download the driver for free from Yaskawa's product and technical information website (<http://www.e-mechatronics.com>).
3. Parameter copy function disabled when connected to a PC.

- Note: 1. You can also use a commercially available USB 2.0 cable (with A-B connectors) for the USB cable.
2. No USB cable is needed to copy parameters to other units.

● PC Cable

Cable used to connect the D1000 to a PC with DriveWizard Plus or DriveWorksEZ installed.
Use a commercially available USB 2.0 cable (A-B connectors, 3 m max.).

Connection

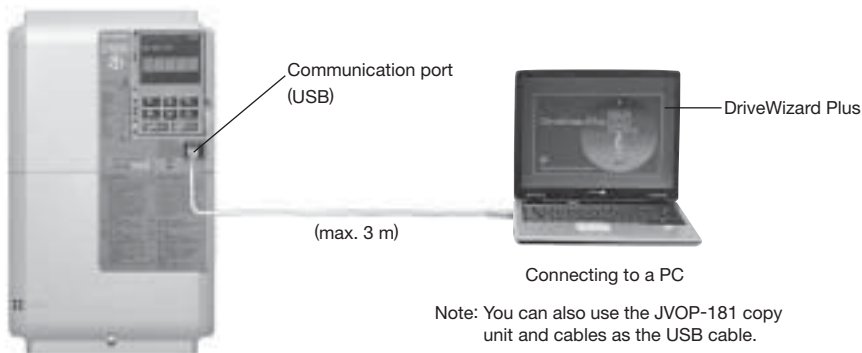

Note: You can also use the JVOP-181 copy unit and cables as the USB cable.

- Note: 1. DriveWizard Plus is a PC software package for managing parameters and functions in Yaskawa drives and energy-saving units. You can download the driver for free from Yaskawa's product and technical information website (<http://www.e-mechatronics.com>).
2. Requires USB driver. You can download the driver for free from Yaskawa's product and technical information website (<http://www.e-mechatronics.com>).

● Application Precautions

■ Installation of D1000 Standard Configuration Devices

You must install both D1000 and the D1000 standard configuration devices.

■ Replacing Previous Models

- If the peripheral devices (i.e., input AC reactors, reactors for harmonic filters, and capacitors for harmonic filters) for previous models (i.e., the VS-656DC3 and VS-656DC5) are used with D1000, abnormal heating may occur. Refer to instruction Manual and adjust D1000 accordingly.
- Do not use the D1000 standard configuration devices with the previous models (i.e., VS-656DC3 and VS-656DC5).

■ D1000 Sequence for Power Loss and Harmonic Filter Installation

Always sequence the power supply for D1000 so that the power supply circuit is opened after the operation of D1000 is stopped.

Always install the specified harmonic filter (harmonic filter module) to reduce the impact of voltage surges on other devices when the circuit opens for any unexpected reason during operation.

■ Installing a Breaker or Contactor on the Unit Output (DC) Side

When installing a breaker or contactor on the D1000 side for an emergency shutoff, confirm that the CHARGE indicators on the drive and D1000 are not lit before closing the breaker or contactor on the D1000 output (DC) side. If the power supply is turned on while there is a voltage charge, an overcurrent will flow and the device may be damaged. Always confirm that the breaker or contactor on the D1000 output (DC) side is turned on before applying power to the D1000.

■ Panel Installation

Install D1000 in a clean environment by either selecting an area free of airborne oil mist, corrosive gas, flammable gas, dust, and lint, or install D1000 in a fully-enclosed panel. If you install D1000 in a panel, determine cooling methods and panel dimensions so that the ambient temperature of D1000 and harmonic filter module are within the allowable temperature range. Do not install D1000 on wood or other inflammable materials.

■ Installation Direction

Install D1000 upright on a wall.

■ Interlocks

An interlock is required between D1000 and a drive to stop the drive if D1000 fails or if an error occurs in D1000. It is also necessary to provide a suitable time to restart the drive if it will be restarted for momentary power losses.

Restarting can be timed with the During MC ON signal that is output from the control circuit terminals of D1000.

Create a sequence to turn off the output from the drive with an external base block input to the drive or by a similar means when the During MC ON signal opens. (Refer to *6 in the Standard Connection Diagram.)

Example 1 Not Restarting for Momentary Power Losses

(Coasting to a Stop for Momentary Power Losses)

Connect the During MC ON output from D1000 to the external fault input on the drive.

Use an N.C. input for the external fault input on the drive and set the drive to detect external faults only during operation to prevent an external fault from being detected when the power supply is turned on.

Example 2 Restarting the System for Momentary Power Losses

Change the setting for the external base block input terminal S8 on the drive from the default setting of an N.O. contact to an N.C. contact.

Connect the During MC ON output from D1000 to the external base block input on the drive. Set restarting for momentary power losses in the drive.

Note: For V1000/J1000, an external base block is not set in the default settings. Set an external base block (N.C.) for one of the multi-function input terminals.

Example 3 Inputting a Run Commands to the Drive

Always input Run Commands to the drive while D1000 is operating. You can check the operating status of D1000 with a During Run 1 signal on a multi-function output. For an example of a drive sequence, refer to *Standard D1000 Connection Diagram*.

■ Wiring Check

Do not short the output terminals or apply voltage to output terminals (U/T1, V/T2, W/T3), because this can cause serious damage to D1000 and the harmonic filter module.

Be sure to perform a careful check of all sequence wiring and other connections before turning the power on. Make sure there are no short circuits on the control terminals (+V, AC, etc.), because this could damage D1000.

■ Inspection and Maintenance

Capacitors in D1000 do not immediately discharge after shutting off the power. After shutting off the power, wait at least the amount of time specified on the unit and harmonic filter module before touching any components. Failure to comply may result in injury to personnel from electrical shock. Take proper precautions to prevent burns, because the heatsink of D1000 and the reactors of the harmonic filter module can get very hot during operation. When replacing the cooling fan, shut off the power to D1000 and wait at least 15 minutes to ensure that the heatsink has cooled down.

Before wiring the harmonic filter module or performing any maintenance, shut off the power and then wait at least the amount of time specified on the module to ensure that the heatsink has cooled down before touching any components.

■ Wiring

Yaskawa recommends using ring terminals on all models. Use only the tools recommended by the terminal manufacturer for crimping.

■ Transporting and Installation

- Do not steam clean D1000 and harmonic filter module. During transport, keep the unit from coming into contact with salts, fluorine, bromine, phthalate esters, and other such harmful chemicals.
- Carry any standard configuration device or peripheral device in a method suitable for the weight of the device. If the devices are handled incorrectly, they may fall and result in injury or device damage.

● Peripheral Devices

- When installing a noise filter on the power supply side, use a reactor type noise filter without a capacitor (such as FINEMET zero-phase reactor) and install it after the MCCB on the power supply side. Do not use a noise filter with a built-in capacitor, because the harmonic components may overheat or damage the capacitor. Install a noise filter recommended by Yaskawa.

■ Installing a Ground Fault Interrupter or an MCCB

Be sure to install an MCCB or an ELCB recommended by Yaskawa on the power supply side of D1000 to protect internal circuitry.

The type of MCCB to be selected varies with the power factor on the power supply side (power supply voltage, output frequency, load characteristics, and others). Sometimes a fairly large MCCB may be required due to the affects of the harmonic current on operating characteristics. If you use an ELCB that is not recommended, use one with harmonic suppression that is designed specifically for drives. A malfunction may be caused by high-frequency leakage current, so the rated current of the ELCB must be 30 mA or higher per drive. If a malfunction occurs in an ELCB without any protection, adjust the carrier frequency of the drive, replace the ELCB with one that has countermeasures against high frequency, or use an ELCB which has a rated current of 200 mA or higher per drive.

Select an MCCB or an ELCB with a rated capacity greater than the short-circuit current for the power supply.

■ Magnetic Contactor for Input Power

Use a magnetic contactor (MC) to ensure that power to D1000 can be completely shut off when necessary. The MC should be wired so that it opens when a fault output terminal is activated.

■ Wire Gauges and Wiring Distance

D1000 phase control can be unstable as a result of voltage loss across a long cable running between D1000 and the power supply. Make sure that appropriate wire gauge is used.

The optional LCD operator requires a dedicated cable to connect to D1000. If an analog signal is sent via the input

terminals to operate D1000, make sure that the cable between the analog operator and D1000 is not longer than 50 m, and that the cable is separated from the main circuit wiring. Use reinforced main circuit and reinforced relay sequence circuitry to prevent inductance from surrounding devices.

To use a multi-function analog input, use twisted shielded pair cables and ground the shield. Refer to the Standard Connection diagram for details.

■ Generator Power Supplies

Select a generator capacity that has at least about twice the capacity of the input power supply to D1000. Contact Yaskawa for details.

Set the deceleration time, load, and other factors so that the regenerative power from the motor is 10% or less of the generator capacity.

■ Connecting a Phase-advance Capacitor or Thyristor-controlled Device to the Power Supply

A phase-advance capacitor is not required for D1000. Installing a phase-advance capacitor will reduce the power factor.

For a phase-advance capacitor already installed on the same power supply system as D1000, install a series reactor on the phase-advance capacitor to prevent oscillation with D1000.

Contact Yaskawa if any device generating voltage surge or voltage distortion, such as the thyristor controller of the DC motor drive or magnetic agitator, uses the same power supply.

■ Countermeasures for EMC (Radio Noise) and High-frequency (Harmonic) Leakage Current

Preventive actions are not required for harmonic current, but preventive actions for EMC (radio noise) or harmonic leakage current are required as for a general drive.

If there are nearby devices that are easily affected by noise, install a zero-phase reactor as a noise filter.

If you install an MCCB or ELCB at the power supply, use an MCCB or ELCB designed for drives. The MCCB or ELCB should have countermeasures for high-frequency leakage current.

■ Impact of Power Supply Distortion

When the power supply voltage is distorted or when several devices are connected in parallel to the same power supply, the relative harmonic content becomes larger, because the harmonics of the power supply system enter D1000.



Global Service Network



Region	Service Area	Service Location	Service Agency	Telephone/Fax
North America	U.S.A.	Chicago (HQ) Los Angeles San Francisco New Jersey Boston Ohio North Carolina	① YASKAWA AMERICA INC.	Headquarters ☎ +1-847-887-7000 FAX +1-847-887-7310
	Mexico	Mexico City	② PILLAR MEXICANA. S.A. DE C.V.	☎ +52-555-660-5553 FAX +52-555-651-5573
South America	South America	São Paulo	③ YASKAWA ELÉTRICO DO BRASIL LTDA.	☎ +55-11-3585-1100 FAX +55-11-5581-8795
	Colombia	Bogota	④ VARIADORES LTD.A.	☎ +57-1-428-4225 FAX +57-1-428-2173
Europe	Europe, South Africa	Frankfurt	⑤ YASKAWA EUROPE GmbH	☎ +49-6196-569-300 FAX +49-6196-569-398
Asia	Japan	Tokyo, offices nationwide	⑥ YASKAWA ELECTRIC CORPORATION (Manufacturing, sales)	☎ +81-3-5402-4502 FAX +81-3-5402-4580
			⑦ YASKAWA ELECTRIC ENGINEERING CORPORATION (After-sales service)	☎ +81-4-2931-1810 FAX +81-4-2931-1811
	South Korea	Seoul	⑧ YASKAWA ELECTRIC KOREA CORPORATION	☎ +82-2-784-7844 FAX +82-2-784-8495
			⑨ YASKAWA ENGINEERING KOREA CORPORATION	☎ +82-2-3775-0337 FAX +82-2-3775-0338
	China	Beijing, Guangzhou, Shanghai	⑩ YASKAWA ELECTRIC (CHINA) CO., LTD.	☎ +86-21-5385-2200 FAX +86-21-5385-3299
	Taiwan	Taipei	⑪ YASKAWA ELECTRIC TAIWAN CORPORATION	☎ +886-2-2502-5003 FAX +886-2-2505-1280
	Singapore	Singapore	⑫ YASKAWA ELECTRIC (SINGAPORE) PTE. LTD.	☎ +65-6282-3003 FAX +65-6289-3003
			⑬ YASKAWA ENGINEERING ASIA-PACIFIC PTE. LTD.	☎ +65-6282-1601 FAX +65-6382-3668
	Thailand	Bangkok	⑭ YASKAWA ELECTRIC (THAILAND) CO., LTD.	☎ +66-2693-2200 FAX +66-2693-4200
	India	Bangalore	⑮ YASKAWA INDIA PRIVATE LIMITED	☎ +91-80-4244-1900 FAX +91-80-4244-1901
Indonesia	Jakarta	⑯ PT. YASKAWA ELECTRIC INDONESIA	☎ +62-21-5794-1845 FAX +62-21-5794-1843	
Oceania	Australia	Sydney (HQ) Melbourne	⑰ ROBOTIC AUTOMATION PTY. LTD.	Headquarters ☎ +61-2-9748-3788 FAX +61-2-9748-3817

Features

Application Examples

Applicable Models

Standard Specifications

Selecting the Capacity

Connection Diagram

Terminal Functions

Dimensions

Fully-Enclosed Design

Peripheral Devices and Options

Application Notes

Global Service Network

D1000

DRIVE CENTER (INVERTER PLANT)

2-13-1, Nishimiyaichi, Yukuhashi, Fukuoka, 824-8511, Japan
Phone 81-930-25-3844 Fax 81-930-25-4369
<http://www.yaskawa.co.jp>

YASKAWA ELECTRIC CORPORATION

New Pier Takeshiba South Tower, 1-16-1, Kaigan, Minatoku, Tokyo, 105-6891, Japan
Phone 81-3-5402-4502 Fax 81-3-5402-4580
<http://www.yaskawa.co.jp>

YASKAWA AMERICA, INC.

2121 Norman Drive South, Waukegan, IL 60085, U.S.A.
Phone 1-800-YASKAWA (927-5292) or 1-847-887-7000 Fax 1-847-887-7310
<http://www.yaskawa.com>

YASKAWA ELÉTRICO DO BRASIL LTDA.

Avenida Piraporinha 777, Diadema, São Paulo, 09950-000, Brazil
Phone 55-11-3585-1100 Fax 55-11-3585-1187
<http://www.yaskawa.com.br>

YASKAWA EUROPE GmbH

Hauptstrasse 185, 65760 Eschborn, Germany
Phone 49-6196-569-300 Fax 49-6196-569-398
<http://www.yaskawa.eu.com>

YASKAWA ELECTRIC KOREA CORPORATION

9F, Kyobo Securities Bldg., 26-4, Yeouido-dong, Yeongdeungpo-gu, Seoul, 150-737, Korea
Phone 82-2-784-7844 Fax 82-2-784-8495
<http://www.yaskawa.co.kr>

YASKAWA ELECTRIC (SINGAPORE) PTE. LTD.

151 Lorong Chuan, #04-02A, New Tech Park 556741, Singapore
Phone 65-6282-3003 Fax 65-6289-3003
<http://www.yaskawa.com.sg>

YASKAWA ELECTRIC (CHINA) CO., LTD.

12F, Carlton Bldg., No.21 HuangHe Road, HuangPu District, Shanghai 200003, China
Phone 86-21-5385-2200 Fax 86-21-5385-3299
<http://www.yaskawa.com.cn>

YASKAWA ELECTRIC (CHINA) CO., LTD. BEIJING OFFICE

Room 1011, Tower W3 Oriental Plaza, No.1 East Chang An Ave.,
Dong Cheng District, Beijing, 100738, China
Phone 86-10-8518-4086 Fax 86-10-8518-4082

YASKAWA ELECTRIC TAIWAN CORPORATION

9F, 16, Nanking E. Rd., Sec. 3, Taipei, 104, Taiwan
Phone 886-2-2502-5003 Fax 886-2-2505-1280
<http://www.yaskawa-taiwan.com.tw>

YASKAWA INDIA PRIVATE LIMITED

#17/A Electronics City, Hosur Road Bangalore 560 100 (Karnataka), India
Phone 91-80-4244-1900 Fax 91-80-4244-1901
<http://www.yaskawaindia.in>



YASKAWA ELECTRIC CORPORATION

In the event that the end user of this product is to be the military and said product is to be employed in any weapons systems or the manufacture thereof, the export will fall under the relevant regulations as stipulated in the Foreign Exchange and Foreign Trade Regulations. Therefore, be sure to follow all procedures and submit all relevant documentation according to any and all rules, regulations and laws that may apply.

Specifications are subject to change without notice for ongoing product modifications and improvements.

© 2014 YASKAWA ELECTRIC CORPORATION. All rights reserved.

LITERATURE NO. KAEP C710656 03C

Published in Japan July 2014 13-1 -0
14-5-13